



SMALL SCIENCE

: Teacher's Book
: Class I and II

Homi Bhabha Curriculum for Primary Science

Homi Bhabha Curriculum for Primary Science
First Edition

S M A L L S C I E N C E

• Teacher's
• Book
Class I & II

**Jayashree Ramadas
Aisha Kawalkar
Sindhu Mathai**

Small Science
Teacher's Book
Class I & II
Pilot Edition, 2004
First Edition, 2011

authors

Jayashree Ramadas
Aisha Kawalkar
Sindhu Mathai

research assistance

Pranita Gopal

primary science co-ordinator

Jayashree Ramadas

general co-ordinator

Arvind Kumar

layout and illustrations

Archana Shinde

cover design

Madhugandha Damle

published by

Homi Bhabha Centre for Science Education
Tata Institute of Fundamental Research
V. N. Purav Marg, Mankhurd
Mumbai 400 088

printed by

Merwin Art Printers
B-44, Chandulal Apartments
Golden Field Compound
Sion-Bandra Link Road
Kalakilla, Sion
Mumbai - 400017

© Homi Bhabha Centre for Science Education, 2004, 2011.

No part of this publication may be reproduced, stored in a retrieval system or transmitted in any form or by any means, electronic, mechanical, photocopying, recording, or otherwise without the prior permission of the publisher.

This book is sold subject to the condition that it shall not by way of trade be lent, re-sold, hired out or otherwise disposed off without the publisher's consent in any form of binding or cover other than that in which it is published.

GENERAL PREFACE

Not a day passes in our country when somebody somewhere has not criticized our system of education, particularly our school education. A great many ills and inadequacies of the system probably flow from extraneous causes and need socio-political initiatives that go beyond mere reforms in school curriculum. But some problems do arise directly from the curriculum - text books, teaching and evaluation practices. There is then a need to keep these problems in view and continually try to devise new curricula to overcome them.

Efforts in curricular reforms and innovations are not new to our country. Nearly every decade or so, there have been initiatives at the Central and State levels to effect changes in curricula. Several independent school networks and voluntary groups have brought out their own textbooks and related materials. There is no doubt that significant progress has been made by the country in increasingly better conceptualization of the school curriculum at primary, middle and secondary levels. The paradigms of school curriculum in India have steadily evolved and become more relevant and modern. Unfortunately, the over-all deterioration of the system due to extraneous factors has tended to obscure these gains. Also, and most important for our purpose here, there is a large gap between the generally agreed objectives of the curriculum and their actual translation into textbooks and teaching practices.

Homi Bhabha Curriculum is basically an attempt to close this gap as much as possible. It is not conceived to be a revolutionary curriculum. The broad aims of the curriculum are much the same as those articulated in countless reports and articles of different education departments and agencies. The idea is not to produce a fanciful, 'museum-piece' curriculum that nobody would adopt, but to attempt to discover a sound and wholesome curriculum that is practical to implement in our school system. 'Practical' is, however, not to be regarded as a euphemism for the status quo. As the users will find out, the alternative textbooks of the Homi Bhabha Curriculum are full of radical unconventional ideas that we believe are both urgent, necessary and, given enough efforts, feasible. But rather than describe here what we believe to be these innovative aspects, we leave the users, students and teachers, to find and experience them. In the simplest and most favourable situations, devising a curriculum and translating it into books, laboratories and teacher manuals is a daunting task. In the complex parameters and constraints that govern our country's educational system, the task is formidable. Only time will tell if and to what extent the Homi Bhabha Curriculum is an effort in the right direction.

Arvind Kumar

PREFACE TO SMALL SCIENCE: CLASS I & II

The series of students' and teachers' books of the Homi Bhabha Curriculum for primary science is the outcome of more than two decades of research and field experience at the Homi Bhabha Centre for Science Education (HBCSE). During these years, several projects have been undertaken to study problems related to pedagogy, communication in the classroom, students' conceptions, text and picture comprehension and cross-cultural issues in science learning. All the members of HBCSE therefore, past and present, have in some way contributed to this curriculum.

The curriculum is built out of simple, thematically organised, activities and exercises. *Small Science Class 1 & 2* deals with the broad area of environmental studies. This Teacher's Book illustrates a few of the almost unlimited learning opportunities offered by our immediate environment. In these first two classes we should remain unconstrained by a definite set of topics; the idea is to simply open up possibilities for learning in everyday contexts.

The aim of this curriculum is to engage students and teachers together in a joyful and meaningful learning experience. We hope that this book succeeds in doing so in your class. Please do share your experiences with us. Your ideas and suggestions for improvement are welcome, via e-mail or through the feedback form provided at the end of the book.

Jayashree Ramadas
jr@hbcse.tifr.res.in

Aisha Kawalkar
aisha@hbcse.tifr.res.in

Sindhu Mathai
sindhu@hbcse.tifr.res.in

ACKNOWLEDGEMENTS

Our heartfelt thanks to all those who contributed to the book:

Arvind Kumar initiated the Homi Bhabha Curriculum and gave constant encouragement.

Pranita Gopal, along with Manasi Sapre and Fouzia Dohadwala, carried out classroom trials during the early stages and contributed many ideas.

Archana Shinde not only did the illustrations and layout but also helped in classroom trials and gave useful inputs. Archana would like to thank Eleanor Watts for inspiration through her simple and elegant stick figures in *The Blackboard Book*.

The principals and teachers of the Children's Aid Society and the Atomic Energy Central Schools 1 and 3 willingly accommodated us. Their students enthusiastically participated in the classroom trials and contributed some ingenious drawings.

Nilesh Nimkar and the teachers of Gram Mangal, Aine in Maharashtra, shared their insights about working with young children.

Chitra Natarajan read the drafts carefully and provided incisive feedback. Geeta Chadha and Sugra Chunawala gave valuable comments. All the HBCSE staff members, especially Ritesh Khunyakari and V. N. Purohit, were very helpful, gladly responding to our innumerable queries.

Jayashree Ramadas

Aisha Kawalkar

Sindhu Mathai

CONTENTS

General Preface	iii
Preface to Class I & II	iv
Acknowledgements	v
Introduction	1
How to use this book	4

UNIT 1

Me and My Family

Topic 1



My family

12

Topic 2

My body



16

Topic 3



Knowing what is around me

19

UNIT 2

Plants and Animals

Topic 4

So many different plants!



22

Topic 5

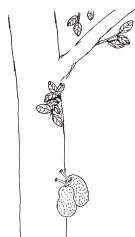

Parts of plants

27



Topic 6 Animals around us 37



UNIT 3
Food

Topic 7 Foodgrains 46

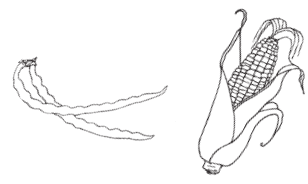

Topic 8 Vegetables 50



Topic 9 Fruits 52

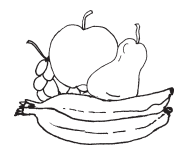

Topic 10 Food from animals 55

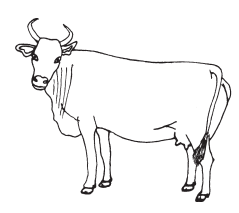

UNIT 4
People and Places

Topic 11 Our school 60



Topic 12

Market



63

Topic 13

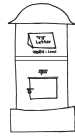

Letters, postman, post-office

66

Topic 14

Buses and bus stops

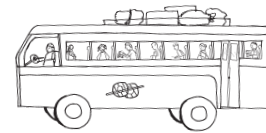

69

Topic 15

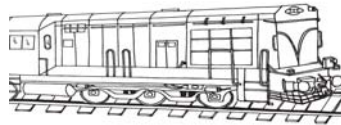

Trains and train stations

72

Topic 16

People at work



75

UNIT 5

Time

Topic 17

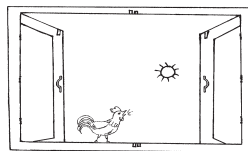

Day and night

78

Topic 18

Calendar

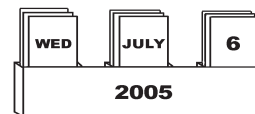

80

Topic 19

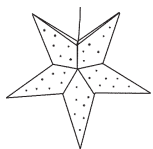

Festivals

86

UNIT 6

Things Around Us

Topic 20

Our classroom

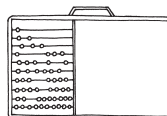

96

Topic 21



Shapes and sizes

98

Topic 22

Going on a ride



105

Games

109

Further Reading

114

Outline of the Homi Bhabha Curriculum (Primary science)

117

Feedback Form

119

INTRODUCTION

The Homi Bhabha Curriculum

Children are by nature curious and observant. They learn about the world by watching, asking questions, and trying to make sense of what they experience. The Homi Bhabha Curriculum for primary science aims to encourage these natural tendencies of students, while at the same time developing in them the basic skills of learning.

The first few years of schooling are critical in shaping the child's attitude towards learning. Will the child see school learning as passive absorption of uninteresting information, or as a continuing adventure, a quest to understand the world around? These early experiences will decide.

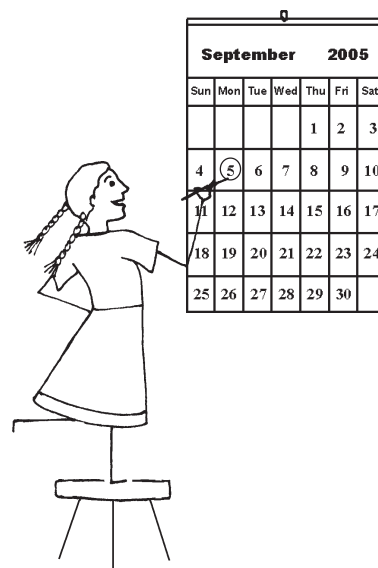

Teacher's Book for Class 1 and 2

The *Small Science TextBooks*, *WorkBooks* and *Teacher's Books* for Classes 3, 4 and 5 suggest a core science curriculum for these years. The purpose of this Teacher's Book for Class 1 and 2 is somewhat different. Firstly, this book goes beyond science into the domain of environmental studies or EVS. The Unit titles, "Me and My Family", "Plants and Animals", "Food", "People and Places", "Time" and "Things Around Us", denote areas of an EVS curriculum.

Although the Unit structure of this book broadly outlines a curriculum, the topics in it are not rigidly prescribed. Within the areas suggested by the Unit titles, only a few indicative topics are dealt with in this book. A particular topic or its suggested treatment might or might not be relevant for your students. For example, "crows" may be part of life in an urban area while "snakes" may be important in a rural area. The specific topics for your class should be selected from your immediate environment. Questions and activities on these topics may be prepared by you based upon your knowledge of your students.

Why only a Teacher's Book?

A question which is often asked of us is, when Classes 3, 4 and 5 of the Homi Bhabha Science Curriculum have a complete set of TextBooks, WorkBooks and Teacher's Books, why do you have only a Teacher's Book for Class 1 and 2?

First of all it is useful to recall that this scheme is consistent with the current policy of the NCERT and the State departments of education. Strong support to the teacher has been the mainstay of the Homi Bhabha Curriculum too, so a Teacher's Book needs no justification.

Yet the question of a TextBook and Workbook for EVS continues to be raised.

A striking observation about students in Class 1 and 2 is that their cognitive and social development, as also their spoken language, is considerably in advance of their literacy and numeracy skills. The risk, in relying on rudimentary reading and writing skills to teach EVS, is that we may end up “dumbing down” the content.

One way out of this problem may be to supplement or replace text with pictures. But observation of pictures cannot substitute for observation of the environment. Further, it is difficult to design a textbook or workbook which communicates through appropriate pictures, yet remains relevant in all environments. Much better that the teacher designs worksheets locally suited to the class. Workbooks are definitely useful for reading, writing and mathematics but, we feel, to beginning EVS learning they remain peripheral.

This is then a resource book, meant to give teachers an idea of the kinds of discussions and activities that students at this age can carry out meaningfully. Students have considerable capacity for learning through close observation and analysis, the only pre-condition being that the observations are carried out in contexts that are familiar to them. You as teacher play a crucial role in directing and facilitating this learning.

EVS and basic skills

Students of Class 1 and 2 are taking their first steps in literacy and numeracy. In many cases they are also coping with a new language, or a medium of instruction which is different from their mother tongue. This difficulty exists to some extent even in the vernacular medium where the informal language spoken at home may be significantly different from the formal language of school.

In this situation one cannot depend critically on reading and writing for the learning of other areas like EVS. On the other hand, EVS affords a rich context to develop and support skills of reading, writing, counting and geometry during the primary years. The various topics in Unit 4, and in Unit 5, the topic of “Calendar”, suggest how guess-reading can be practiced by students to achieve functional literacy and numeracy. In Unit 6, the topics “Our classroom” and “Shapes and sizes” introduce various mathematical concepts through everyday situations. This skill development in language and mathematics continues through Classes 3, 4 and 5 of *Small Science*.

Students entering school have come a long way in the development of their overall cognitive capabilities. If they have grown up in a reasonably unrestricted environment, they would have mastered a variety of perceptual, motor and analytical skills already. These skills should now be supported and further developed through the EVS curriculum, through carefully designed activities, questions and cues for observations.

These early years are important too for the development of social awareness and social skills. Topics like, “My Family”, “People at Work” and “Festivals” focus specifically on social awareness. The overall approach continually encourages meaningful social interaction in and outside the classroom.

Learning through the environment

Children can surprise us with their perceptive observations. Yet, in the early years of school we adults systematically underestimate their capabilities. The school curriculum forces them to attend selectively to a few simple, almost trivial, facts and generalisations - a situation that is particularly prevalent when learning happens in a language different from the mother tongue.



It is easy to break out of this naive, bookish approach by taking advantage of the possibilities afforded by our everyday experiences. The environment is rich in opportunities for learning. To begin with, we have to convey to students that their own observations, ideas and activities are important and valued in the classroom. Then we provide a structure in which these ideas can be expressed, analysed and evaluated by the students themselves. The rest will follow.

Assessment

The aims of this curriculum, as elaborated in later books of *Small Science*, prominently include observation of the environment, design and engineering, language development, quantitative thinking and social sensitivity. In Class 1 and 2 we develop preparatory skills in these areas. Further we have added some parameters to assess all-round development relevant to EVS. For details, see pages 8-9.

HOW TO USE THIS BOOK

Format of the book

There are two types of text in this book. One is the “student text” which is given in the following kind of font:

*Activity 6.1: Observe these two animals. Notice the differences between them.
Notice also the similarities.*

These are questions and instructions that you the teacher would be directing at the students. This “student text” is given in a different font type to differentiate it from the “teacher text” which carries explanations, suggestions or additional information, as below:

This exercise will arouse students’ curiosity and initiate them into observing and thinking about animals. Choose any two familiar and somewhat similar animals for comparison, say a dog and a cow, a sparrow and a pigeon, or a bee and an ant. Wherever feasible this exercise should be done with the animals actually present in front of the children.

For reasons of space, it has not always been possible to write the “student text” in conversational child-friendly language. You will need to simplify the questions and frame them in ways relevant to your students. For example:

“We have something interesting here today. Look at the earthworm in this glass. Have you seen an earthworm before? ... etc. Now look at this little caterpillar. Don’t be afraid, they will not hurt you. And you should not try to hurt them either ... etc. Now tell me the differences you see between this caterpillar and this earthworm ... ”

If this sounds daunting, you might begin in a more traditional way, recalling some prior experiences:

*“How many of you have seen a dog? ... and how many of you have seen a donkey?
... Now tell me what is different ... think of as many differences as you can ... etc.”*

Before you start to use the book, skim through it to make sure you can identify the student text and the teacher text.

Selection of topics

This single book serves as Teacher’s Book for classes 1 and 2 of Small Science. The distribution of topics and questions between the two classes is left to your judgement. Remember that though some of the topics might be common to the two classes, their level of treatment would be different.

To plan the topics for the year, begin by reading this book thoroughly. Select a few topics and then go through their treatment suggested here, to mark out the parts suitable for your class. Generally the first few questions and activities in any section of a topic are suitable for Class 1. Topic 1 and the first part of Topic 20 are particularly recommended for the beginning of the school year. Maintain a record of which topics or parts of topics are done in the course of the year. Such a record kept in Class 1 will be most helpful to the teacher in Class 2.

When it comes to discussion, children have short attention spans. Remember that anyone topic is not intended to be completed at a stretch. Break up the topics into small parts while teaching - this will also enable students to go back and observe and participate more effectively when that topic is continued later. You need not maintain the serial order of topics given in this book.

Selection of questions

Under each topic, the student text gives a number of questions while the teacher text may indicate a variety of possible answers for each question. The questions and pointers are meant to stimulate discussion, to encourage students to talk and to recall their real-life experiences on which further learning can be built. The questions encourage the habit of keen observation and enquiry. With practice students will be able to frame their own questions too.

The questions aim to be fairly comprehensive. The teacher must decide, depending on the readiness and interests of the class and the relevance of the topic, how deeply to explore it. Rather than trying to exhaust all the questions on a particular topic, it may be better to go with the flow of the discussion. The difficulty level of questions and activities need to be adjusted to your class. Remember that each student is not expected to answer every question. Take care that the lesson is not reduced to a volley of questions on some topic to which students cannot relate.

Language development

Move towards a gradual adoption of English or whichever is your medium of instruction. Initially students may be better able to understand and to express themselves in the local language or in their mother tongue. They should be allowed to do this without interruption or excessive correction. Re-phrase questions in more than one way, so that all students have a chance to understand. Encourage the quietest students to participate in the discussions.

As a general rule keep your sentences simple and avoid unnecessary use of difficult words. If however the context is familiar then new words will certainly empower students to describe their experiences effectively. In that case you may yourself first need to get familiar with the words (as for example, the names of trees, or the terms connected with trains). If students lack the relevant experiences then do not attempt to teach too many new words.

Collect stories, action-songs and poems appropriate for various topics and occasions. The readings suggested on pages 114 to 116 will be helpful.

Develop and support literacy by providing plenty of opportunities for reading. Begin with activities like matching words on identical labels (Activity 2.3), then go on to writing one-word responses on the blackboard and having students read them out (as on page 52), matching pictures with words (Blackboard work on page 23), and then choosing from a few words from the blackboard to write labels for their drawings (Activity 1.3).

Activities

After short spells of discussion, involve the students in activities. Plan the activities in advance - what materials have to be brought and whether they have to be conducted indoors or outdoors, with the whole class, in small groups, in pairs, or individually. If possible ask colleagues or parents to help out in the classroom. It is a good idea to designate one or two students as "helpers for the day". These students could distribute materials or help in other organisation. Other suggestions in *Small Science Class 4 Teacher's Book* pages 7-9 may be helpful.

Drawing :

Drawing a picture and colouring it enlivens the topic and helps students express their ideas. It also helps develop design and draftsmanship. Encourage students to draw independently and, rather than copying standard pictures, come out with their own novel ideas. Let the students talk about what they have drawn. Initially you may need to encourage them with questions, but later you will find them more forthcoming with their descriptions. You will find that the students' imagination and creativity leap far ahead of their drawing skills!

As you check each student's work and listen to their explanations, write down next to their drawings some simple words, labeling what is there, or what is happening in the picture. Over time, this practice will inspire students to do the labeling themselves, thus promoting writing skills too.

Students' observation prior to doing the topic in the class will reflect in their drawings. So also drawings will encourage further observation of details they would not have noticed earlier. Good observation is thus not only a prerequisite for good drawing but it gets keener after it. For instance, students often draw a typical five-petalled flower shape, not giving much thought to which plant it represents. After spending time observing different types of plants (trees, shrubs, climbers, as also flowers, leaves and fruits of different types) students will get a broader sense of plant life and be able to make more connections with the plant life around them. You will discover this in their drawings!

Do show in class pictures or photographs from books, charts or magazines. These would illustrate a variety and diversity not necessarily found in the immediate environment - as for example in butterflies, flowers, insects, birds, plants, occupations, vehicles, and so many other topics. You may freely use the drawings in this book for blackboard illustrations.

Model-making :

Many of the model-making activities have been left to your interpretation. They may be made as simple or as elaborate as you and the students wish. A quick improvisation, for example, pretending that an empty box is a bus, is always possible. On the other hand a planned exercise of making a model bus will develop in students several important skills and abilities including, designing, geometrical drawing and counting.

Making simple origami models is good for developing fine-motor and geometrical skills. Due to space constraints only a few descriptions for making origami models are given here. Please refer further to books on simple origami, like the ones listed on page 114.

Acting-out :

The acting-out exercises too could be done at many levels. Judge the capability of the students. Better observation will lead to richer acting and vice versa. At times the class may together dramatise a story or a scene from a story told in the class. Keep in the school a small collection of props and accessories useful for acting scenes.

Counting :

In Class 1 and 2 students are expected to learn to count till 100. Supportive activities for developing the concept of number could be taken up during discussion on any topic, for example:

“How many students are here who walk from home to school - raise your hands ... and count the hands”. Counting of objects should be done wherever possible.

Incorporate in your teaching, rhymes and songs like, “One, two, three-four-five, once I caught a fish alive ... “ or, in Hindi, “*Dus mote haathi jhoom ke chale ...* “. Completing pictures by joining numbered dots would be fun as well.

Field visits :

Field visits to different places like a garden, a market, a nearby bus-stop or post-office, to meet people in various occupations, are invaluable in learning these topics. Planned walks serve well as a starter or follow-up for topics like smells, sounds, colours, shapes, observing plants, as also animals including birds and insects. Try to find out beforehand what interesting things can be seen, or decide which plants or flowers etc. are to be shown. Do stop to look what arrests children’s attention. Pick up various small things fallen on the ground like, twigs, stones of interesting shapes and colours, seeds, pods, etc.. If possible at the site, or on returning, let the students draw and talk about what they saw, learnt and collected.

You will need another teacher or a helper to accompany you during these outings. Before going out of the classroom, give students simple, clear instructions for what to observe, or give them say two questions to which they have to find answers. Most importantly, lay down firm rules for behaviour: the success of a field trip is enhanced by its orderly conduct.

Display of student's work :

To show that their work is appreciated, arrange displays of students' drawings, models and other things they make, or bring from home for activities (for example, cereals and pulses). Regularly changing displays make the classroom look interesting and alive. Over the year try to exhibit the work of all the students, and select across the range of abilities, ensuring that those missed out this time get noticed the next time.

Prepare with the help of students, charts with specimen, pictures and words related to topics being done in the class.

Discovery corner :

Choose a space in the classroom to keep novel objects of all kinds, not necessarily related to any particular topic. Encourage students to bring in interesting things to exhibit here. This display could change daily. The objects might be pebbles, feathers, bones, shells, seeds, simple mechanical gizmos, broken or other throw-away things ... Take care to avoid sharp edges and heavy objects. Let students examine the things, handle them and talk about them before or after the class.

Odds and ends :

Store old discarded things in a cardboard box or a cloth bag in the classroom. Collect in it empty bottles, bottle tops, cardboard boxes, pieces of wood, threads or cords, different cloth materials, old baskets, bags and so on. These objects will come in useful in counting, sorting, model-making and other exercises. Also they may serve as props for acting-out scenes.

Method of assessment

Classes 3, 4 and 5 of *Small Science* have a continuous assessment system built into the WorkBooks. In Class 1 and 2 we recommend a similar continuous assessment of every student's contribution in the classroom. The assessment at this level should be informal, based on the students' participation in discussions and activities. In addition, their regular drawing and writing in their notebooks might be taken into consideration.

This type of assessment will inform you about the students' progress and potential. More importantly, it will provide you with feedback to decide what to teach and how to teach it. The assessment sheets of the students in Class 1 will be especially helpful to the teacher of Class 2.

A model assessment sheet is given on page 10. In the Table on page 9 we list the same categories along with a few examples of activities which involve these skills.

Some examples of activities related to assessment categories:

Categories	Some Examples of Activities
1. Participation in discussions	
2. Recollection and narration	9.5, 11.2, 5.18, 19.1
3. Observation	4.2, 5.9, 6.18, 14.3, 17.4
4. Sensory skills	3.1, 5.11, 7.1, 9.1
5. Reading	Blackboard activities, 4.5
6. Writing	5.6, 10.7, 13.3, 18.5
7. Sorting	6.7, 20.4
8. Counting	10.4, 11.6, 18.2, 20.2
9. Geometry	21.10, 21.11
10. Estimation	10.5, 21.3, 21.6, 21.18
11. Drawing	1.2, 4.6, 6.13, 11.1, 18.5, 2.1
12. Model-making	6.6, 6.10, 7.7, 14.1
13. Acting-out	1.4, 4.5, 15.6, 17.1, 20.8
14. Social awareness	
15. Independent thinking and creativity	
16. Co-operation with other students	
17. Enthusiasm in doing activities	
18. Completion of home assignments	

You will notice that the activities often involve a combination of skills. As an example, Activity 1.2 could be used to assess not only drawing but also observation and writing. During any classroom discussion, many different skills will be expressed, certainly not just recollection and narration but also observation, reading, counting, independent thinking and social awareness.

Please maintain an assessment sheet for each student and note down in it remarks about the student's performance in the different categories. The assessment could be carried out after one Unit has been completed, or even after a combination of a few Units or some parts of them are done. It might perhaps more conveniently be done at regular intervals during the year, coinciding with the examination schedule in your school. But remember to be relaxed and informal, do not treat it as an examination!

Assessment Sheet

Name

Assessment period

Participation in discussions

Recollection and narration

.....

.....

Observation

Sensory skills

.....

.....

Reading

Writing

.....

.....

Sorting

Counting

.....

.....

Geometry

Estimation

.....

.....

Drawing

Model-making

.....

.....

Acting-out

Social awareness

.....

.....

Independent thinking and creativity

Working methodically

.....

.....

Patience and concentration

Co-operation with other students

.....

.....

Enthusiasm in doing activities

Completion of home assignments

.....

.....

Other remarks

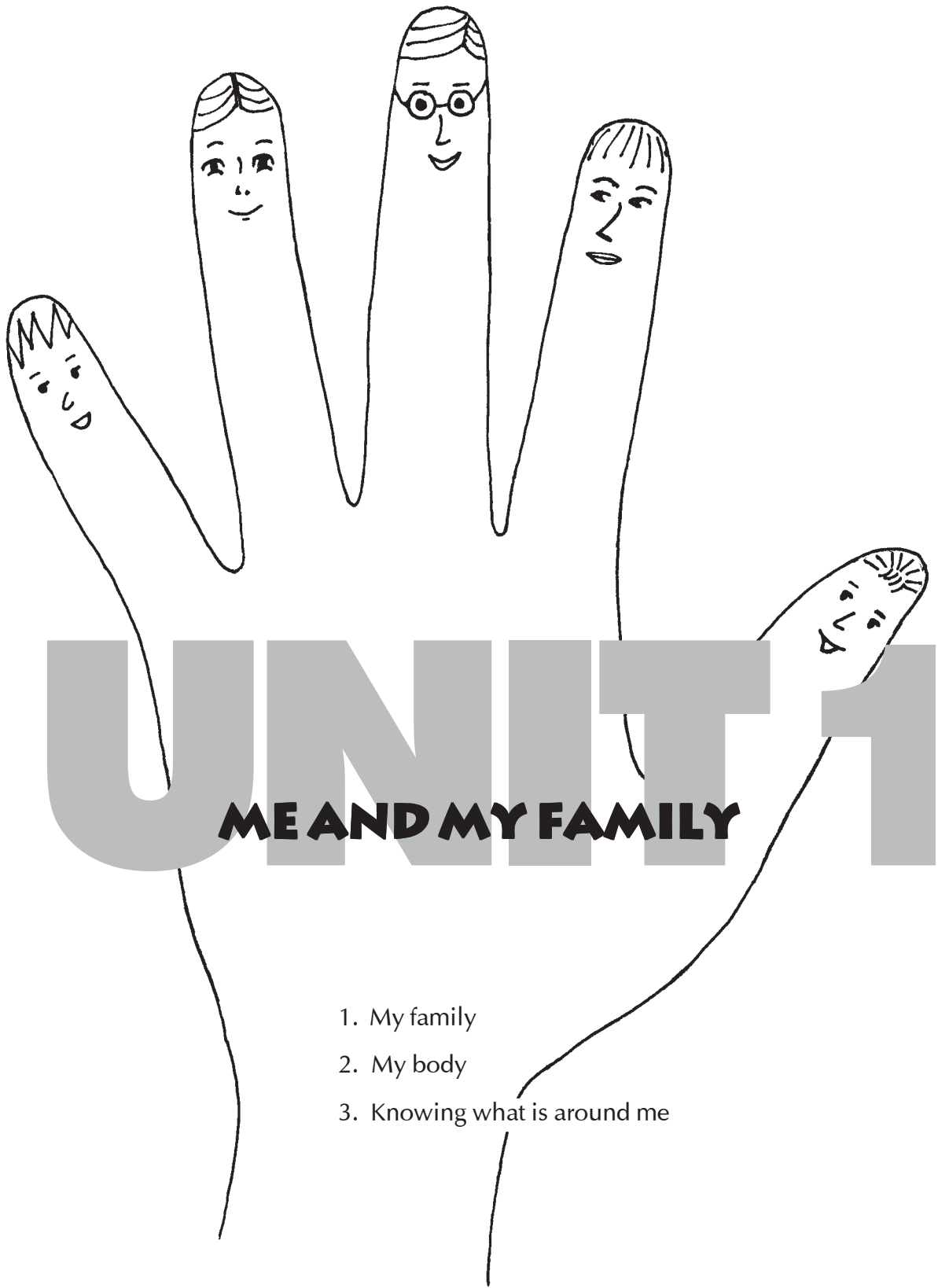

UNIT 1

ME AND MY FAMILY

1. My family
2. My body
3. Knowing what is around me

1. MY FAMILY

This is a good topic to begin the new school year. Talking about ourselves and our families should create a relaxed atmosphere in the classroom besides serving to introduce students to the teacher and to each-other. You as teacher should start by introducing yourself in an informal and interesting way (for example, the place you come from, your hobbies ...).

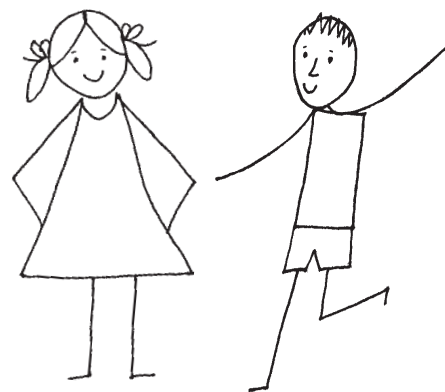

Myself

What is your name? Do your friends or family call you by some pet name?

If possible get the students' full names in complete sentences, without being too formal about it.

Where do you live? Nearby? Some distance away? What is your address? Who are all the persons living in your house? Any close family members living away from the home?



Mother

By what name do you call your mother?

Ma, Amma, Aai, Mummy ... use these same terms in further conversations.

Count how many students use a particular name.

Students raise their hands for each name, then one student counts.

What is her real name? If you do not know, ask her.

Depending on how prepared the students are, encourage and help them to answer in full sentences like, "My mother's name is _____."

What all things do you do with your mother? What kind of clothes does your mother wear? Do you like to wear such clothes? Do you sometimes in play dress up like your mother?

Count how many mothers wear particular kind of clothes, like saris (worn in different styles), salwaar kameez, skirts, pants, etc.

What all does your mother do at home? Does your mother work outside the house? What does she do?

Activity 1.1: Play "Home"!

Act like your mother or father or any other member of your family. Act out some everyday scene in your home. Act out a scene in which some visitors come to your house.

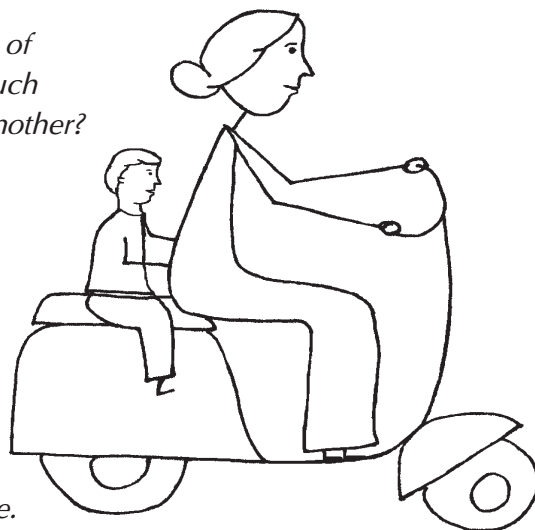



Father

Questions to parallel those for mother:

By what name do you call your father?

Papa, Baba, Abba ...

What is your father's real name? If you do not know, ask him.

What all things do you do with your father?

What clothes does your father wear? Do you like to wear such clothes? Do you sometimes in play dress up like your father?

What all does your father do at home? Does your father work outside the house? What does he do?

In any classroom there may be significant variation in cultures and in socio-economic status of families. Questions on work and lifestyles should therefore be handled with sensitivity. Encourage an appreciation of different lifestyles. Emphasise the role of women as well as men.

Activity 1.2: *Draw a picture of your mother or father doing some work. Write their name next to the picture.*

How do you help your parents in the house? Do your sisters and brothers also help around the house? In what way?

Sister, Brother, Cousin

How many sisters and brothers do you have? Are they older than you (big) or younger (small)?



How many of you have an elder sister or brother? How do you call her or him? What is her or his name? In which class is (s)he studying? Does (s)he play with you? help in your studies? fight with you? etc.

How many of you have a younger sister or brother (name, age)? Does (s)he have teeth? What all does (s)he do (crawl? sit up? walk or run? jump? babble? talk? what else? any naughty things)? What does (s)he eat? How do you play with her or him? Do you trouble or are troubled by her or him?

Act like (imitate) your younger sister or brother.

You may similarly discuss cousin sisters and brothers.



Grandfather, Grandmother

By what name do you call them? Describe what they look like. What do they do? Do they tell you stories (name some), help with your school work?

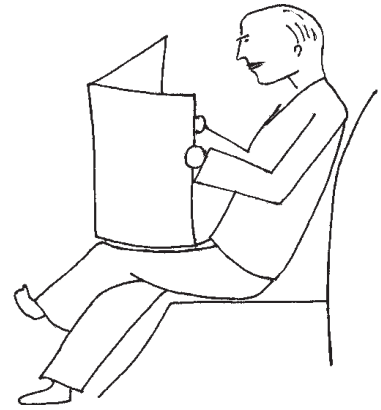

Other family members

Any other family members in the home eg., uncles, aunts? Talk about them.

Any family members whom you visit or who visit you, say in the vacations ...?

Any recent functions in the family? Which relatives and friends did you meet then?

Pets

Do you have a pet or domestic animal?

Explain that "animal" includes birds, turtles, fishes, etc. Some people might keep frogs, snakes and lizards too.

What is your pet's name? What food does it eat? What all does it do? Do you play with your pet?

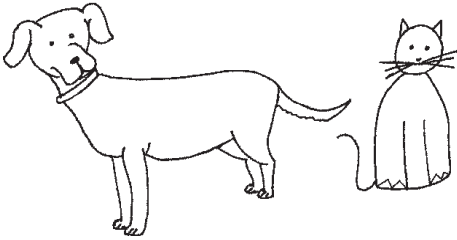







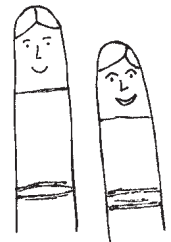













Activity 1.3: Draw a picture showing the members of your family. Select words from the list on the blackboard - My mother, My father, Myself, My sister, My grandfather... and write them under the pictures. Write their names too.

Count how many members are there in your family and write down, "I have _____ people in my family".

Activity 1.4: Finger puppets - Choose different fingers of your hand as the members of your family and draw their faces. Make them talk to each other.



Blackboard work:

How many family members?	Number of Students
 _____	0
  _____	1
   _____	5
    _____	10
     _____	17
      _____	4

How many of you have only one member in your family? How many of you have two, three ...

Draw with the help of stick figures, a family with one member, two members ... Ask students to raise their hands then count and write how many students in the class have that many members in their family.

How we address our parents

	"Mother!"	"Father!"
Manipuri	Ima	Impa
Assamese	Maa	Deotaa
Hindi/Hindustani/ Urdu	Maa, Amma, Mataram Ammi, Ammijaan, Ammiji	Pitaji, Babuji, Bauji, Baba Abba, Abbu, Abbajaan, Abbaji
Punjabi	Maa, Bebe, Bibi, Chaiji	Bapu, Baba, Papaji, Paaji
Sindhi	Ammi, Amma, Bhabhi	Abba, Baba
Gujarati	Baa	Bapu, Bapuji
Marathi	Aai, Aay, Aaye, Baye, Nani, Vahu	Baba, Dada, Nana, Anna, Bhau, Appa, Tatyaa, Bappa, Ba
Konkani	Mai	Anna
Kannada	Amma, Avva	Appa, Anna
Malayalam	Amma, Amme Umma, Ammachi	Acchan, Acchaa Uppa, Appacchan
Tamil	Amma	Appa
Telugu	Amma	Naana, Nayna, Appa, Ayya
Oriya	Bau	Bappa
Bengali	Maa, Maago	Baba

Student's Drawings

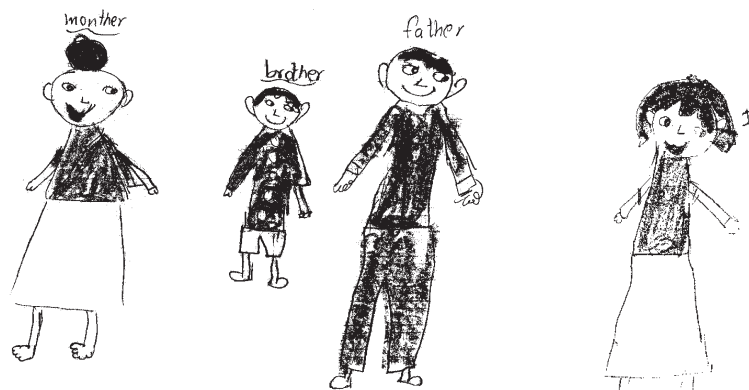

2. MY BODY

The purpose of these activities is to get to know one's body while learning names of the parts of the body. The terms "left" and "right" are also introduced.

Parts of the body

How many different actions can you do with your body while remaining in one place? Do them.

Show how many different actions you can do with your body if you are allowed to move from one place to another.

Depending on the size of the class and the space available, these actions could be done by one or more students at one time. Alternatively they might be tried outside the classroom.

See how many kinds of expressions you can show with your face.

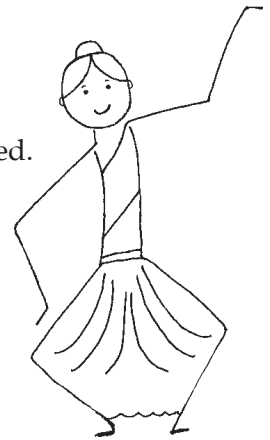

Write words like "happy", "sad", "angry", "afraid", "surprised" on the blackboard and explain them. Then write them on chits of paper. Call each student in turn to pick up one chit. Students act out this expression, without making any sound. Others should guess their mood.

Nod, nod, nod, shake your head

In how many ways can you move it, you said?

Blink, blink, raise your eyebrows

Pucker those lips, wiggle that nose

Wrinkle the forehead, run fingers through hair

Raise your chin, fill cheeks with air

Open your mouth, show teeth within

Hold your tongue out and then in!

Hold your ears, raise your shoulders

Put up both arms and wiggle ten fingers ...

Raise your right arm, then the left arm.

While introducing the terms "left" and "right" to the students see that you are facing in the same direction as the students or else they may get confused.

Point to your elbows, wrists, hands, palms and fingers. What actions can you do using your hands only?

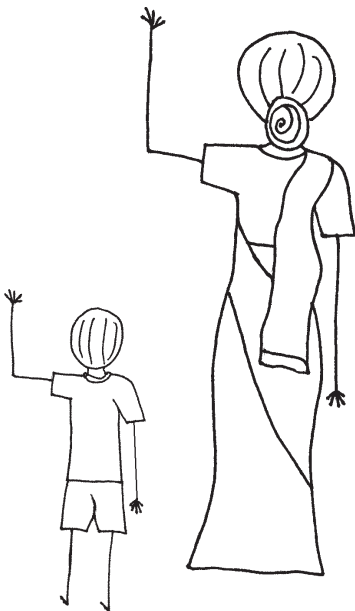

Clap in different ways.

You may clap first in various rhythms and ask students to repeat after you, for example,

1,2 1,2 1,2
1,2,3 1,2,3 1, 2, 3
1,2,3,4,5 1,2,3,4,5 1,2,3,4,5



Snap your fingers. Count and tell how many fingers you have. Are the fingers of one hand of the same size? Which finger is the tallest, shortest, thinnest, thickest? Make shadow figures with your hands and fingers.

Activity 2.1: *Dip your fingers or palms in watercolour and press them on paper to make designs. Make pictures of animals, people, flowers or fruits using your thumb-marks. Some of you together make a simple drawing and fill it with colourful thumb-marks.*

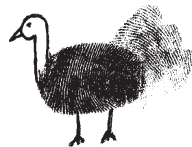

Point to your chest, belly, back, buttocks. Point to your thighs, knees, calves, feet and toes. How many toes do you have? What actions can you do using just your feet and toes?

Stamp your feet, first left, then right, left, right ... Hold your right knee with your right hand, left knee with right hand and so on.

Sing an action song!

There are a number of action songs in different languages involving parts of the body. In English there are songs like "Boogie Woogie" or "Hokey Pokey": "You put your left leg in and your left leg out, you put your left leg in and you shake it all about, you do a boogie woogie and you turn yourself around, that's what it's all about", etc. There are also several rhymes involving finger actions.

Let's play "Simon says ..."

If instructions are prefixed with "Simon says ..." like, "Simon says clap your hands", then students follow them but if an instruction is given without "Simon says ..." then they are not to follow it - if they do they are out.

How many _____ do you have?

Ask this question for different parts of the body.

Which body parts do you have in pairs, that is two in number?

Activity 2.2: Make paper clothes.

Draw some stick figures on a sheet of paper. With the students' help draw and tear or cut out a variety of dresses from paper or cloth.

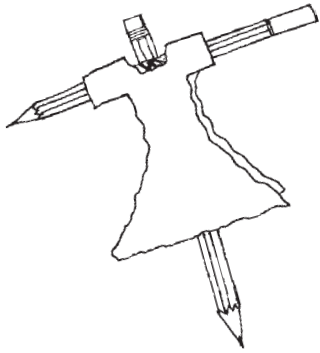
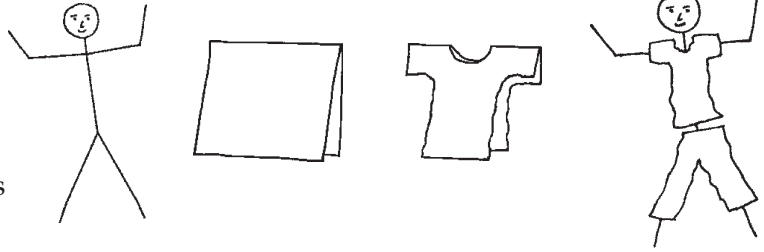

Paste the dresses on the stick figures. Ask about the different lengths of the dresses - are they above, up to or below the knees, up to the ankles ... are they without sleeves or with short sleeves, sleeves upto the elbows or full sleeves ...? You may also make paper clothes for pencil figures.

Activity 2.3: Match the labels.

Draw a picture of a child on chart paper or on a flannel board. Prepare a set of labels by writing names of various body parts on pieces of paper or cardboard from old notebook covers. Distribute the labels among the students.

Read out your label and stick it next to the part of the body written on it.

If students are at a very early stage of literacy, the picture could already be labelled. The students will then match their labels to these and try to recognise the word.

Keeping neat and clean

Each one of you bring to class one thing you use to keep your body clean and tidy like, a toothbrush, comb, soap, towel, etc..

Now act out one of these - brushing teeth, rinsing mouth, washing face, having a bath, combing hair, washing hands and feet, cutting nails ...

How we grow

Do your old clothes fit you now? What do you do with old clothes? Bring to class some of your old clothes which are now too small for you.

Are there things you can do or any places you can reach, which you could not do when you were younger or which a younger child cannot do?

Teacher might suggest some examples.

! Take Care

Be careful while trying to reach for places you cannot - don't fall and hurt yourself.

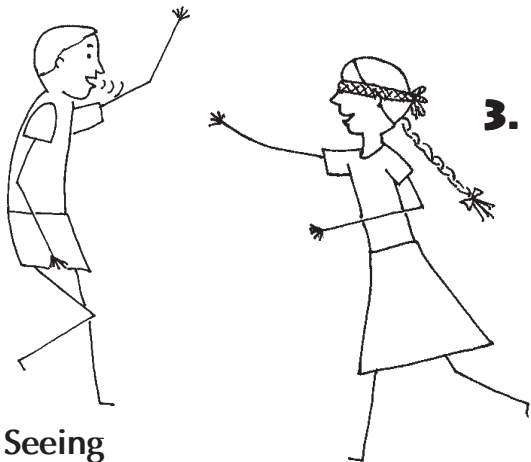

3. KNOWING WHAT IS AROUND ME

The aim is to increase students' sensory awareness and to encourage them to use their senses of sight, hearing, touch, smell and taste to know more about the world around them.

Seeing

Close your eyes or blindfold yourself. Stay this way for few minutes. What are the things you can do with your eyes closed and what things is it difficult to do? One of you try to catch your friends with your eyes blindfolded.

What sights make you feel very happy? What colours do you like? What is the biggest thing you have seen? Smallest? Which shapes do you know?

We get to know about things by seeing them, observing their shape, size, colour, etc.. We also learn more about them by their sound, touch, smell and taste.

Hearing

Activity 3.1: Keep your eyes closed and listen carefully to sounds made with some objects. Guess which objects could make these sounds. Can you hear the sound well if your ears are covered?

Example set: hollow objects like bottle or ball, wooden and plastic rulers, chalk, coins, marbles, pack of cards, a leafy branch ... The objects might be placed behind a screen. Create sounds by shaking, tapping, scraping, hitting on a table, dropping on the ground or flipping (for example, the pack of cards).

Have a friend stand behind you and speak or sing. Can you recognise who it is by the sound alone? Do you know any person with a voice very different or interesting? Do you know someone who can whistle a song?

Are there any places that you recognise by their sounds? What sounds do you hear in the kitchen, on roads, in your school, in a forest, a field ...?

Recall some sounds, make different sounds of your own. Remember the sounds of musical instruments, the sound of rain, of flowing water, of any bird or animal ...

Which sounds are loud, soft? Which sounds do you like? Which sounds make you happy? Have you ever got scared or irritated by some sound?

Touching

Activity 3.2: *Close your eyes. A friend will keep in front of you a tray full of things. Pick up one of these things and guess what it is with your eyes closed.*

Example set: paper, book, pencil, eraser, spoon, ribbon, candle, piece of ice ... For older children you may include objects with more similarities like, a set of different leaves, different types of seeds or dried fruit, or pieces of different types of fabric, like cotton, jute, wool, silk, chiffon. The things may also be kept in a cloth or paper bag or a cardboard box with a hole to put in a hand. Another interesting modification may be to ask children to pick out pairs of similar things (for example, two chikoo seeds) by touch alone.

Name some things which feel smooth, rough, slippery, soft, hard, sharp, pointed, wet, moist, dry, hot, warm or cold ...

Your friend will trace an alphabet on your back with her or his finger. Guess it! Try to recognise simple (3 or 4 letter) words in this way.

Smelling

Activity 3.3: *Remain blindfolded while a friend holds something near your nose. Guess what it is, without touching it! With your nose pressed shut can you still recognise it?*

Describe the smell - is it pleasant or unpleasant, sweet, sour or sharp ...?

Example set: pieces of fruits like lemon, orange, pineapple; petals of fragrant flowers like rose, jasmine; crushed leaves like curry leaf, coriander, neem, mint, betel leaf; strong-smelling cut vegetables like onion, radish, garlic; crushed spices like cardamom, cloves, cinnamon; some everyday objects with distinctive smells like fresh newspaper, eraser, leather purse ... The objects may be tied in a cloth or put in a small paper bag.



Are there any places that you can recognise by smell alone? Which smells do you like, which do you not? Name some things which do not have any smell.

Tasting

Activity 3.4: *The teacher will give you something to taste. Guess what it is.*

Example set: grain of salt, sugar, tamarind, jaggery, pieces of fruits, *roti*, pickle ...

Name some things which are sweet, sour, salty, bitter or hot.

Now guess, which parts of our body help us to see, hear, feel, smell and taste?



UNIT 2

PLANTS AND ANIMALS

4. So many different plants!
5. Parts of plants
6. Animals around us

4. SO MANY DIFFERENT PLANTS!

The topic aims to make children aware of the variety of plants that they see in their surroundings. The questions below should stimulate students to look closely at the plants around them: near the school, around the house or garden and while travelling. Occasions like outdoor walks and class picnics are ideal for carrying out observations in the form of games with the whole class.

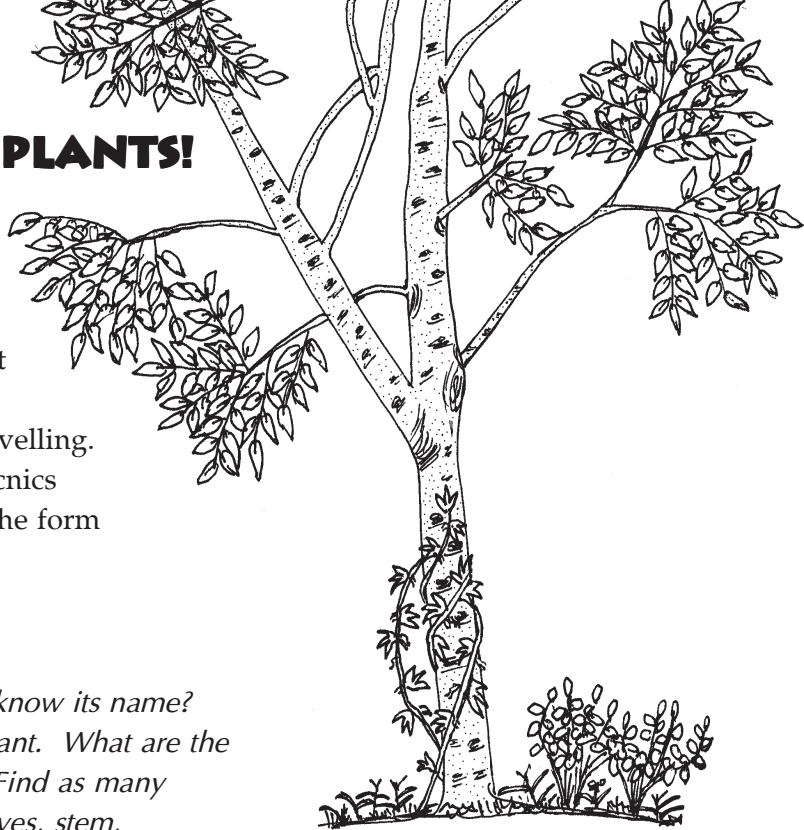

Watch out for plants!

Activity 4.1: Meet a plant ... Do you know its name? Now compare it with another nearby plant. What are the differences between these two plants? Find as many differences as you can. Look at the leaves, stem, branches, flowers and fruits (if any). In what ways are these plants similar?

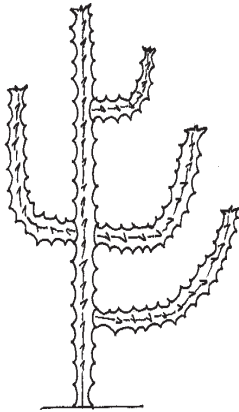

Select any two nearby trees or small plants, preferably those which might be of interest to the children due to their attractive flowers or leaves or edible fruits or playtime possibilities.

Note the words that students use in their description. They would have their own ways of describing plants, perhaps with words like, tall, short, big, small, fat, thin, thick, green, yellow, brown, etc. They may also know words for parts of plants, like leaves, flowers, stem, branches, trunk and roots. Try to use the students' own words in discussions, while also introducing simple new vocabulary.

Activity 4.2: Outdoor game
Take this leaf, go search out the plant that it came from. Also look at the other plants around. Which ones do you recognise by name?

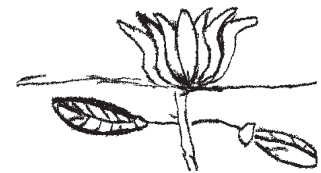

Student's Drawings

Blackboard work: Match the names of parts of the plant with parts shown in the picture.

Again, the purpose is to become familiar with a few words describing parts of a plant: words needed later to talk about various types of plants.

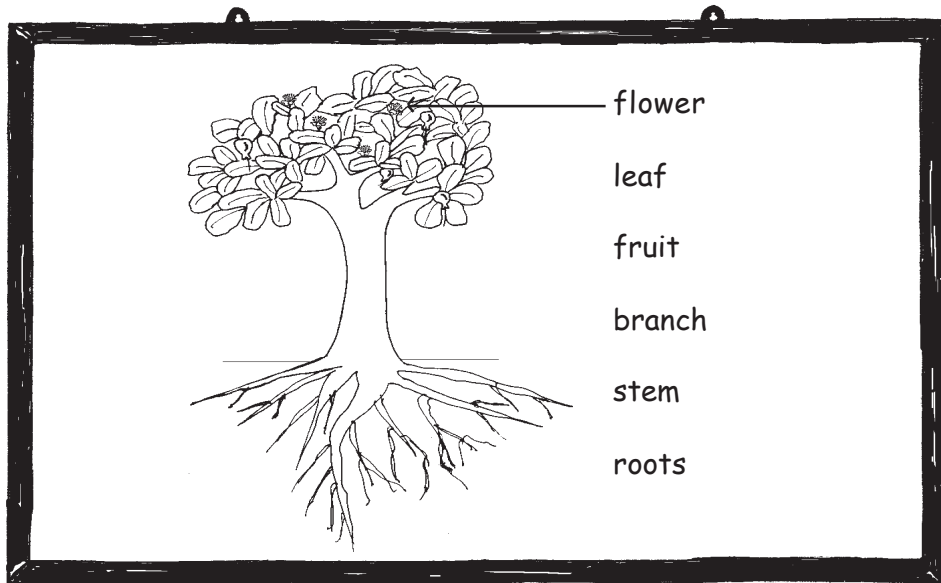

You may uproot a small weed to show the parts of the plant. Later on press the weed between sheets of a newspaper. When it is dry stick it on to a chart paper with labels for the plant parts.

Blackboard work: Which different plants do you know? Which have you really seen?

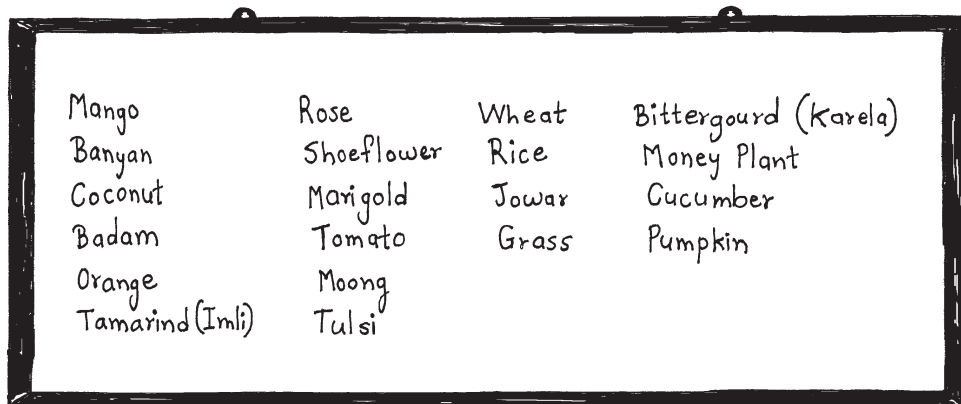

Write the names of plants suggested by students on the board: you may organise these in categories like, trees, shrubs and herbs, grasses, climbers and creepers.

Tell me about some of these plants, how do they look? Which of them are very big, which are small? Which of them stand straight, which do not?

Show the students a tree and a shrub. Ask them to notice the differences in size and stem of these plants.

Trees

Some kinds of plants after many years become big and tall trees. The stem of the plant grows into a thick, woody trunk, which supports a crown of branches, with leaves, flowers and fruits. Which of the plants that you named are trees? Which are the most common trees around you?

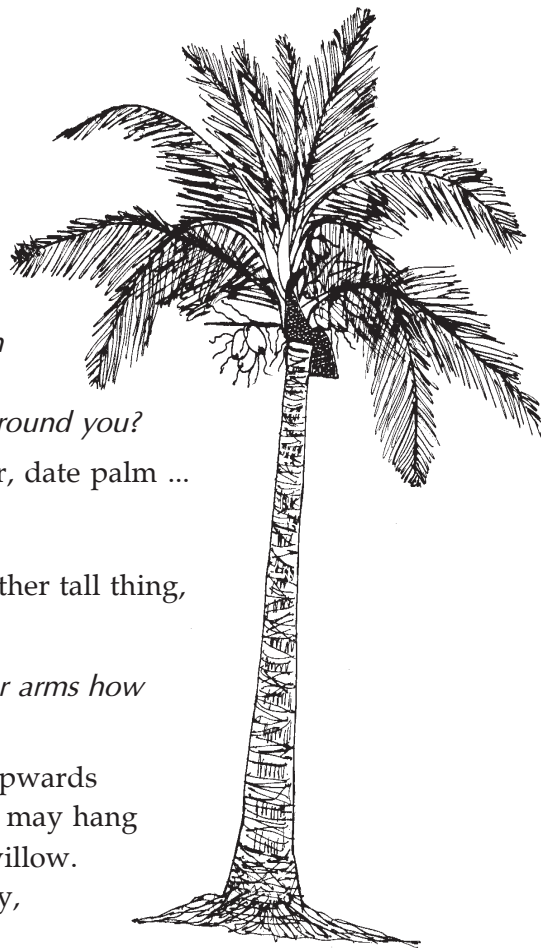

Some more trees: peepal, banyan, teak, deodar, gulmohar, date palm ...

Look at any nearby tree and describe how tall it is.

Compare the height of the tree with the height of some other tall thing, like a building or an electricity pole or another tree.

Look carefully at the branches of trees. Show with your arms how the branches have spread.

Some branches may spread outwards, some may point upwards like in the Indian coral tree (*Erythrina* species), yet others may hang down towards the ground, like the pink cassia and the willow. Some trees have branches which are arranged very neatly, like the copper pod (*Peltophorum inerme*).

Try to draw the shapes of some trees.

Some trees are shaped like an umbrella. The leaf canopies of some trees have a flat base like the christmas tree (*Araucaria* species) and the red silk cotton tree (*Bombax ceiba*).

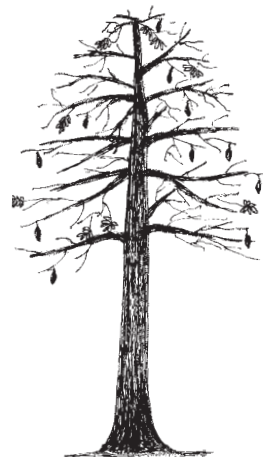

Sit down under a tree (preferably a large, shady tree). Close your eyes and listen. Do you hear sounds made by squirrels, birds or insects on the tree? Find out the names of the birds which visit the tree. Do you hear the rustling of leaves? Do leaves of all trees make sounds when the wind blows through them? Do some trees make louder rustling sounds?

On long journeys by bus or train, notice carefully many different types of trees.

Shrubs and herbs

Shrubs do not grow as tall as trees. They usually have hard stems and branches.

Some shrubs: shoeflower, jasmine, *bhindi*, tomato, brinjal ...

Herbs are usually smaller than shrubs. Herbs have soft stems and branches.

Some herbs: *tulsi*, coriander and pulses like *toor* or *arhar*, *moong*, *masoor* ...

Recall where you have seen shrubs or herbs. Perhaps you have walked through fields or along roads with plants on both sides. Were these plants taller than you or shorter? Describe their smells, colours, shapes, flowers, fruit, and anything else you noticed about them.

Are there shrubs or herbs in or around your home - in your garden or kept in pots? Find out the names of these plants and ask why these plants have been grown there: for pleasing surroundings? pretty flowers or leaves? for food? or medicine? Have you seen shrubs grown as hedges to mark a boundary? In a garden you may have seen several shrubs all of the same height. How do you think that might have happened?

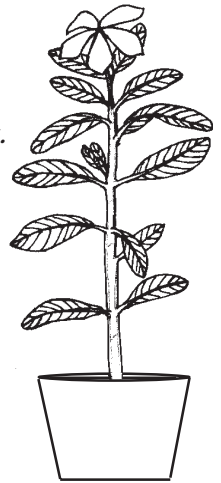

Grasses

Grasses have thin, long leaves, but no branches.

Show the students a shrub and a grass. Ask them to notice the difference in size, stem and leaves. Grasses are the most common types of plants. You see them everywhere: in fields, on hills, on the sides of roads, in gardens and playgrounds. Even food-grain cereals like rice, wheat, *jowar*, *ragi* and corn are kinds of grasses! Bamboo and sugarcane are huge grasses! "Lawns" are made by planting a single kind of grass, usually with fine, soft leaves, on a patch of land and keeping it trimmed evenly.

Activity 4.3: *Bring different kinds of grasses to the class. Do you know the names of some of these? Arrange an exhibition of these grasses in your class.*

Children in rural areas would know many different kinds of grasses which are used for different purposes like, animal grazing, thatching, weaving, making ropes, as medicines, for religious ceremonies (for example *durva*), etc.

Have you ever walked through tall grass or through a rice field? What happens when a strong wind blows through a grassy field? Which kind of plants move or sway the most - grasses, shrubs or trees? Try to explain why there is a difference in the way they move.

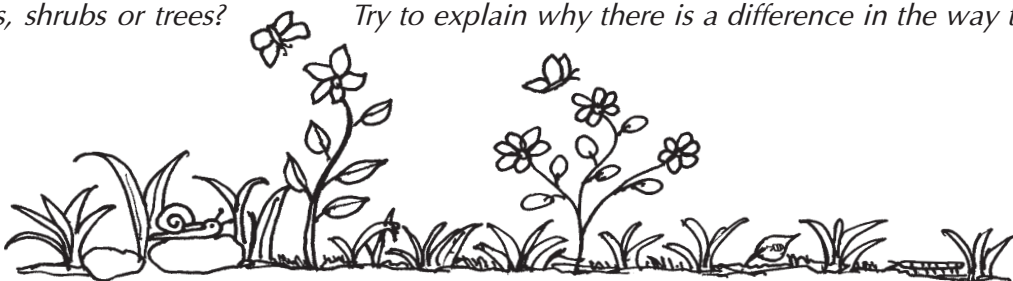

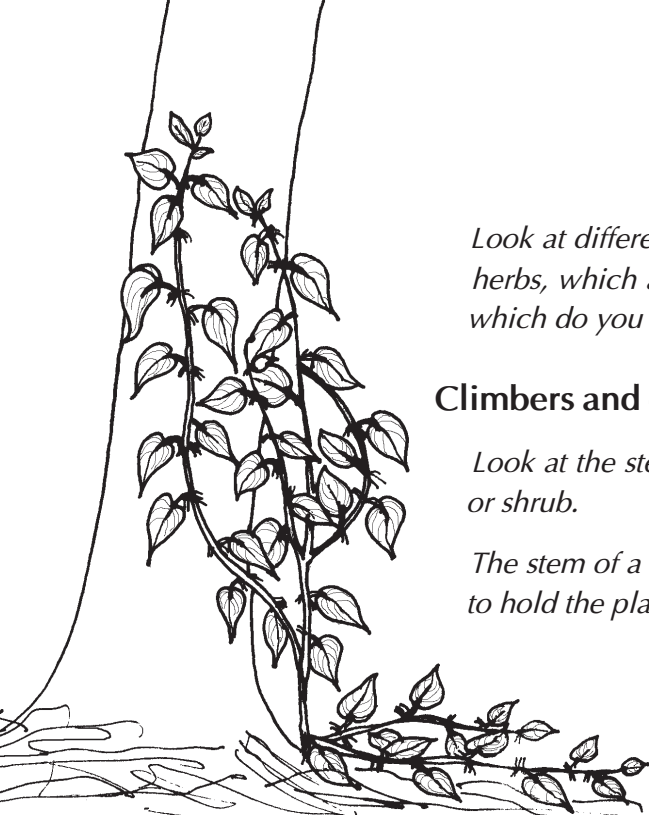

Look at different small plants around your school. Which are shrubs, herbs, which are grasses? Which plant parts do you see in them, which do you not?

Climbers and creepers

Look at the stem of a climber. Compare it with the stem of a tree or shrub.

The stem of a climber is long and thin like a rope. It is not stiff enough to hold the plant upright.

A climber grows along a support (such as a stick) or around a shrub or a tree. Usually its stem has small hooks or tendrils which wind around the support.

Which climbers do you know?

Some more climbers: *karela* (bitter gourd), *tendli*, grapes, money plant (*Pothos* species), betel plant, *madhumalti* (*Quisqualis indica*), railway creeper (*Ipomoea palmata*) ...

A creeper grows along the ground.

The two words "climber" and "creeper" may refer to the same kind of plant, though some plants which grow heavy fruit, like watermelon and pumpkins, need to grow or creep horizontally rather than climb.

Where have you seen climbers or creepers? Have you seen climbers growing on other trees? on fences? Why do you think climbers are grown on fences?

Activity 4.5: *Act out a scene in which some of you pretend to be trees, shrubs, climbers and creepers. A few of you can be animals or people in this scene.*

Activity 4.6: *Draw a field or a garden with lots of plants - see that you have many different kinds of them!!*

Plants are so useful!

Plants make the air fresh for us to breathe. Without plants we would not be alive!

Have you watched animals eating the leaves of plants? Which animals have you seen visiting or eating plants? Which plants were they?

Which trees around you give a nice, large shade that you like to sit in? Which trees do you like to climb or play under?

Find out some plants of which people use, wood, leaves, flowers, fruits or anything else. Find out about a plant which is used as a medicine. What part of it is used?

Find any poems, stories, legends or beliefs relating to plants.

5. PARTS OF PLANTS

Just like we have different parts like hands, legs ... plants too have different parts. These parts are useful to the plant in some way.

Stem or Trunk

The stem of a plant is long and green or brown in colour. The stem supports branches, leaves, flowers and fruits. The stem keeps the plant standing straight.

The stem of a tree is called a trunk. We get wood from the trunk of trees. Wood is used for making furniture (desks, cupboards ...).

Name some other things made from wood. Show some things in this classroom which are made from wood.

Look at the stem of a shrub, creeper or climber and the trunk of a tree. Are they similar or different? Touch each stem or trunk and describe it: what is its colour? Is it smooth or rough? Soft or hard? The stem of a creeper may look weak. Do you think it may break easily? Do you see any juice or gum on the stem? Any insects on it?

Activity 5.1: Bark rubbing

Materials needed: A blank unruled piece of paper, pencil or crayon.

Hold the paper against the bark of the tree and gently shade with a pencil or crayon. The pattern of the bark will form on the paper. Rub over barks of different trees and compare these patterns. Make a display of different bark rubbings.

(See also *Small Science Class 3 Teacher's Book*, pages 45-46).

Notice the colour and designs on the bark. Can you recognise the tree by seeing only the trunk?

Activity 5.2: Collect pieces of bark that might be peeling off a tree. Exhibit the barks along with the names of the trees.

The stem and branches of some plants are covered with thorns or spines. Do you know any such plants?

Roots

The roots of a plant usually grow below the ground. They help to keep the plant fixed in the same place.

Uproot a small weed and look at its roots.

Large trees have thick roots which spread wide and go deep under the ground. You cannot see roots that go deep down but sometimes you may see a few roots above the ground, at some distance away from the tree, or on the side of a road which is cut through a hill. The banyan tree has also special roots which grow out from the branches and down into the ground.

Have you seen any other plants with roots that are seen above the ground, like some palm trees, jowar ...?

Leaves

Activity 5.3: *Compare two leaves from two different plants. Find as many differences between them as you can. Describe the shape of the two leaves, compare their sizes, colour, texture, how they are arranged on the plant.*

Two leaves with visibly different types of shapes could be compared, for example, the leaves of railway creeper (*Ipomoea palmata*) and Indian almond or *desi badam* (*Terminalia catappa*).

Colour: *What is the colour of these two leaves? Even if both are green, are they of the same shade of green? Do some plants have leaves of other colours too?*

These may be shades or patterns of green, yellow, red, brown, purple, pink ... Croton, *Tradescantia* species, *Rhoea discolor* have leaves of several different colours.

Are the tiny young leaves of these plants of a different colour from the older leaves? What is the colour of the old leaves? Of dried leaves?

What happens to leaves after they become dry? Do you think that the leaves that are now on the tree were there last year too? Look for leaves fallen on the ground - what is their colour? Compare them with fresh leaves.

Young leaves of mango, peepal and mast tree or false ashoka (*Polyalthia longifolia*) are reddish-brown and shiny. As they grow they become green. Later they turn yellow or brown. The exact sequence and colours may differ for each plant.

Shape: *Describe differences in shape of the two leaves.*



Leaves can be of so many different shapes. Some are broad, while some are thin and long. Leaf of the railway creeper is shaped like a star or a butterfly while that of Indian almond is oval or like a person's head. (These descriptions were given by children of Class 2.)

Texture: *How do the leaves feel when you touch them?*

Some leaves are smooth while some are rough like those of teak, *bokeda* (*Ficus hispida*) and parijat. Some are even hairy, like the leaves of tomato and *Mussaenda*.



Look at the leaf near a window or in sufficient sunlight. Does it look shiny?

The shoeflower leaf is a shiny, dark green but the *aboli* leaf is a dull green.

Edges: Some leaves have smooth edges, others have wavy or zig-zag edges.

Veins: Have you noticed the lines in a leaf, they are veins. Veins give shape to the leaf. They can be seen as designs or patterns on the leaf. Try to copy these patterns. Look for the different patterns of veins in leaves. Compare the veins in palak and methi leaves. Now compare with the pattern on the grasses.



Palak leaves have prominent branched veins. In methi leaves, only the vein in the centre (midrib) is seen. In grasses the veins are parallel rather than being branched.

Arrangement of leaves on the stem: Are the leaves arranged in a bunch or are they single? Do you see some pattern or design in the way the leaves are arranged? Try to draw the patterns.

Examples: copper pod, mango, papaya trees.

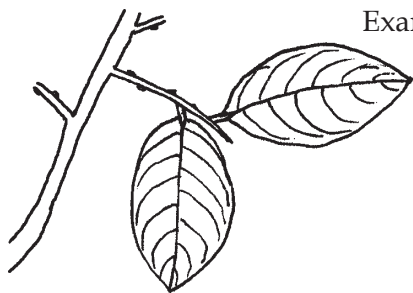

Activity 5.4: Look at a leaf given to you. Notice its colour and shape. Feel it between your fingers. Touch the upper and lower surfaces of the leaf, do they feel the same? Is the colour of the leaf same on both the sides? Look at the patterns on it. Run your finger along its edges. Describe in your own words how the leaf looks and feels. Does it have any smell?

Activity 5.5: Bring different kinds of leaves to the class. Arrange them from the smallest to the largest.

Example of such an arrangement : *tulsi*, mango, *badam*, banana

Sort the leaves into those having similar edges, shades, feel or design on leaves.



Activity 5.6: Observe and draw a few different leaves. Write one or two words to tell how a leaf is different from the others.

Activity 5.7: Leaf rubbing

Materials needed: Leaves, a blank sheet of paper, pencil or crayon.

Press the paper over the back of a leaf with prominent veins, and shade over the paper gently. The pattern of the leaf will show up on the paper. Compare the patterns made with leaves of different plants. Make a display of your leaf rubbings.

Activity 5.8: Look how the leaves tear!

Tear different leaves of various plants. Notice any difference in the way they tear. How does the leaf of a grass tear? Try to explain why different leaves tear in different ways.



The grass leaf tears into straight strips but the leaf of a shrub tears in a zig-zag line. This observation could be used to draw attention to the veins or lines on the leaves which are peculiarly parallel in grasses and in palm leaflets (monocotyledonous plants).

Bring to class some leaves that we can eat. What are their names? Do you wash these leaves before eating? Do you need to cook them?

The class may share a snack consisting of edible leaves. Rural and tribal communities in India know of a large variety of edible leaves. Children in these communities too are highly knowledgeable about edible leaves, flowers, fruit and seeds. The class may make a display of edible leaves.

! Take Care
Do not eat any leaf unless you know it is safe!



Flowers

A flower is usually the most colourful part of a plant, with a pleasant smell too! Remember some flowers - describe their colours, shapes, sizes and smells. Recall flowers that grow on large trees and those that grow on smaller plants.

Which are your favourite flowers? Why do you like these flowers?

Activity 5.9: *Watch a flower bloom*

Keep a potted flowering plant in the class, close to a window where it will get plenty of sunlight. Remember to water it every day! Tie a piece of coloured thread loosely around the stem of a bud or a flower. Watch the flower every day and tell the class what changes you see.

This activity may be done with the thread tied to the stem below any growing part of the plant. In this way students will be able to observe the plant grow from day to day.

What differences can you see in these two pictures?

Tie a thread around the stalk of a bud on a lemon tree.

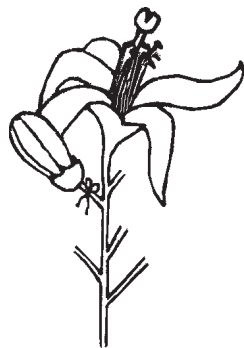

After five days, the lemon bud blooms into a flower, while the flower is replaced by a tiny lemon fruit.

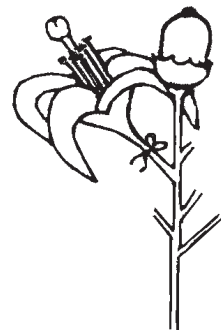

Activity 5.10: *Bring some different flowers to the class. Do you know the names of these flowers?*

The most colourful and prominent part of a flower are the petals. Look at the colours of the petals. Count the number of petals. What is the shape of each petal?

Besides drawing, children may describe the shape in words. Some examples given by students of Class 2: like a hand, half-moon shaped, wavy, smooth, zig-zag, crooked, flat ...

In some flowers the petals may be all joined together, like the flower of the railway creeper.

Sort the flowers into groups according to their colour. Sorting could also be done according to size, number of petals or whether the flowers have any smell.

Have you been near a place with jasmine plants? Think of some other flowers with strong (pleasant or unpleasant) smells.

Some flowers, like jasmine, parijat have a strong smell that you can detect even from a distance.

Do you know any flowers which smell strongest in the night?

night jasmine, tuberose or *nishigandha*

Which are the flowers whose smells you do not like?

The response would depend on individual preference, but examples could be baobab (*Adansonia digitata*) and thorn apple (*Sterculia foetida*).

Think of some flowers with mild or almost no smell.

Activity 5.11: *Guess the flower from the smell*

Materials needed: Petals of some common flowers with characteristic smells.

Examples: rose, marigold, jasmine, champa (*Plumaria* species) ...

To make things more interesting, the petals of the various flowers could be torn into small pieces. It would be better if the flower petals were all of the same colour (but the flowers were actually from different plants), so that it would be difficult to distinguish them by the colour. Each student would get a few bits of the petals, and be asked to identify the flower based on smell alone.

Which is the smallest flower that you have seen? How small was it?

Compare the size of this flower with something of similar size.

Which is the biggest flower that you have seen? How big was it?

Plants like coriander, mango, neem and most of the grasses have very small flowers. On the other hand, plants like lotus and canna have large flowers. Some plants get many tiny flowers in bunches. Some get only a few big flowers.

Can we cook and eat any flower?

We eat cauliflower, and also the flowers of pumpkin, drumstick, banana and neem. The petals of some flowers (like the rose, tamarind and *mahua*) can even be eaten raw. Rose petals preserved in sugar (*gulkand*) are said to have medicinal value.

! Take Care
Never eat a flower unless you know that it is safe!

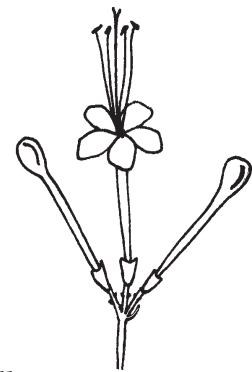

Have you seen bees or butterflies visiting flowers? Watch and guess what they do there. You might also see some small insects crawling into flowers. Are some flowers visited more often by insects?

Some flowers like *aboli*, *sadaphuli*, *parijat* have hollow stalks (you can insert a pin into one end of the stalk and see it coming out from the other end).

Activity 5.12: Paint with petals and leaves

Materials needed: coloured flowers, paper.

Holi is the festival of colours. Holi colours can be made using dyes from leaves and petals of flowers. Petals and leaves can also be used for colouring on paper.

Rub the leaves and petals directly on paper to make colourful paintings.

Give each student a few leaves and some petals of different flowers. Get them to wash hands properly after the activity. Examples of some leaves and flowers that could be used:

Leaves:

henna or *mehndi* (*Lawsonia inermis*) : green

goldmohar or gulmohar (*Delonix regia*) : green

bougainvillea : pink, peach, orange - the bracts of the bougainvillea flower are used for painting. (A bract is a modified leaf which is found just below the flower or a group of flowers, above the stalk of the flower(s).)

Flowers:

flame of the forest or *palash* or *dhak* (*Butea frondosa* / *Butea monosperma*) : red, orange

gulmohar (*Delonix regia*) : red

marigold or *genda* (*Tagetes erecta*) : yellow, orange

shoeflower (*Hibiscus rosasinensis*) : purple

copper pod (*Peltophorum inerme*) : yellow

coral tree or *pangara* (*Erythrina* species) : red

rose or *gulab* (*Rosa* species) : red, yellow

chitrak (*Plumbago zeylanica*) : blue

chrysanthemum (*Chrysanthemum indicum*) : yellow

Indian laburnum (*Cassia fistula*) : yellow

parijat (*Nyctanthes arbor-tristis*) - tubes are used : orange

Activity 5.13: Join the dots, guess the flower

Materials needed: The outline of a flower in the form of serially numbered dots.

Join the dots with a pencil following the order of the numbers. Now try and guess which flower it is.

The activity is fun. It also provides practice in reading numerals in correct order.

Activity 5.14: Pressing flowers and leaves

Materials needed: Flowers (preferably medium-sized), for example, *Ixora coccinea*, phlox, firecracker flower or *aboli* (*Crossandra undulaefolia*), shoeflower, flowers of grasses, leaves, old newspapers and books, chart paper.

Spread the flower or leaf in such a way that you can see most of it. Press it gently between the folds of a sheet of newspaper, taking care not to crumple the petals of the flower too much. Keep a book over the newspaper to keep it pressed. The flower or leaf will slowly dry up. Change its position every few days, till it is completely dry. Now you may take the flower or leaf out of the newspaper. Glue one or several of these on to a card paper or paper and use it as a decorative piece or convert it into a greeting card.

When a flower or leaf is just plucked from a plant, it is fresh. After a while it droops and fades. How could we keep it looking nice even if it is not fresh?

Flowers and leaves may stay fresh for a few extra days if we keep their stems in water. If dried properly they will keep their shape, though the colour may change. Why do we press flowers to preserve them? To preserve means to retain the features of that object even after it dies or fades. Try keeping the flower without pressing and see what happens.

Activity 5.15: Spatter or spray patterns

Place a pressed flower or leaf on a blank sheet of paper. With the help of an old toothbrush spray water-colour around the flower or leaf without disturbing it. When the colour dries remove the flower or leaf.

Activity 5.16: Make a rangoli with flowers

This activity may be done in groups in a convenient open space. Alternatively, each student may make a small rangoli pattern on a sheet of cardboard.

Materials needed: flowers of different colours, chalk.

Draw a rangoli design on the floor with a piece of chalk. You may think of your own design or get one from a book. Use flower petals to fill in the pattern.

Remember, do not pluck too many flowers from the plant!! You may be able to find fallen flowers nearby which have not dried up completely - use them for the rangoli.

Fruits

Some flowers grow into fruits. Have you seen a mango tree in bloom? A few days or a week later, you might have seen the whole tree bearing several tiny mango fruits. Fruits of many plants are tasty to eat like, guava, mango, grapes and coconut.

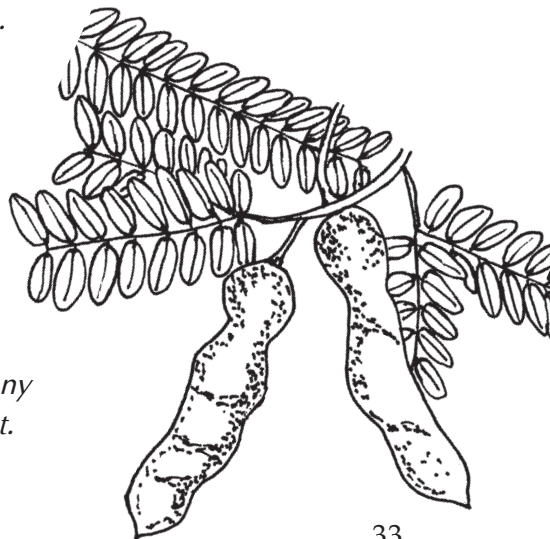

Do all plants, shrubs and trees have fruits? Does the rose plant too have fruits?

Which fruit trees have you seen? Look for fruits of as many plants as you can. Some fruits may be shaped like beans! Look for seeds in all the fruits.

Can the fruits of all plants be eaten? Are there fruits that other animals eat but we do not?

! Take Care

Never eat a fruit unless you know that it is safe! Wash fruits well before eating them.

More on fruits in the Topic 9, pages 52 to 54.

Activity 5.17: Drawing and colouring

Observe a plant (as described in Topic 4). Draw a leaf, a flower and the whole plant. See if your drawings resemble the real plant: is the overall size and shape of the plant in your drawing, similar to the plant that you have seen? How thick or thin is the stem? Are there patterns on the stem? For leaves check out the size, shape, margin, pattern of veins and arrangement of leaves on the stem. For flowers check the shape, number of petals and their colours.

Activity 5.18: Your own collection - Nature journal

Materials required: a scrap-book or fullscape sheets of paper, gum.

On the way to school or when you go out for a walk, collect different kinds of leaves that catch your attention - large and small, of various colours, shapes or pattern of veins. Collect flowers too which you would like to keep with you and look at later on. Press them within sheets of newspaper (as described in Activity 5.14); stick them in your scrap-book. As far as possible, collect fallen or dry material. You may also pick up fallen seeds, pods or twigs. If you know the plant from which you got the material write its name below the preserved material.

A chart could also be made using pressed flowers and leaves.

Activity 5.19: Note the seasonal changes in the plants on the calendar of that month.

The calendar activity is described in Topic 18, pages 84-85. The following observations are best done as part of this activity. Students will be able to answer these questions only after repeated observations over several months.

While you are walking outdoors, or on your way to school, get into the habit of watching the trees and plants around you. Do you see flowers on all plants? Do you see flowers on these same plants throughout the year? Notice which months of the year you see particular kinds of flower(s) blooming. In which months do you not see them?

*Watch also what is there on the ground below the trees. At times, under some trees like peepal and desi badam you might see fallen leaves, under the copper pod and gulmohar trees you might see fallen flowers or parts of fallen flowers. Under the trees of banyan (*Ficus bengalensis*), peepal (*Ficus religiosa*) and umbar (*Ficus glomerata*) you might see fallen fruits.*

Have you seen a tree with no leaves at all? When have you seen it that way? Later in the year did new leaves grow on that tree?

Have you seen a tree full of flowers but with no leaves?

Each festival in the month is depicted in the calendar with the help of a symbol. Pictures of related plants - the whole plant, flower or fruit, could be used to depict a festival or the seasonal changes during that time. For example, towards the season of *Vasant Panchami*, the mango trees start to get their spring bloom. These flowers may be drawn to depict the new season of spring.

Children's observations about some plants

1. Children of Classes 1 and 2 were asked to observe and draw these plants. (The terms below are translated from spoken Marathi child language.)

What is observed shoeflower

Leaf shiny, smooth
 Leaf margin zig-zag
 Colour of flower red
 Number of petals five
 Any other structure (staminal) tube
 Petals



Student's Drawing

aboli

Leaf rough
 Leaf margin zig-zag
 Colour of flower orange and yellow
 Number of petals three
 Petals very soft



The students seemed a bit confused about the number of petals in aboli, since the shape of the petals was rather misleading.

2. Comparison between two shrubs (shoeflower and periwinkle):

shoeflower

Flower colour red
 Leaf colour dark green
 Leaf margin serrated
 Size of leaf broad
 Size of the flower big
 Leaf texture shiny
 Other structures (staminal) tube



periwinkle



pink
 light green
 smooth
 narrow
 small
 not shiny
 none





3. Comparison between a shrub and a tree (shoeflower and mango tree):

	shoeflower		mango
Plant	shrub		tree
Leaves	smaller rough		bigger smooth
Flowers	red, big not in bunch		yellow, small in a bunch

4. Comparison between a creeper and a tree (railway creeper and Indian almond):

	railway creeper		Indian almond
Plant	creeper/ climber		tree
Size of the leaf	small		big
Shape of the leaf	butterfly, star		man's head, oval
Texture of the leaf	not shiny		shiny
Veins	not prominent		prominent

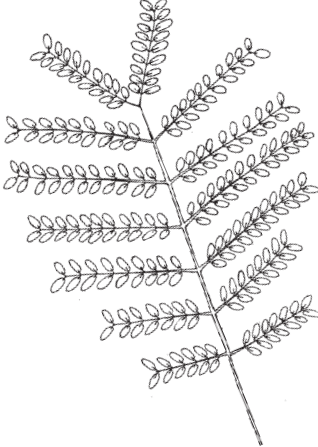
5. Comparison between leaves of two plants (mango leaves and copper pod leaflets):

	mango		copper pod
Size	large		small
Colour	parrot green		green
Texture	ironed out shiny		not ironed out not shiny
Veins	prominent		only middle vein seen
Leaf stalk	green		brown
Tip of leaf	pointed		rounded

New words

trunk, bark, veins, stalk, preserve, petals, margin, texture, symbol

Student's Drawings





6. ANIMALS AROUND US

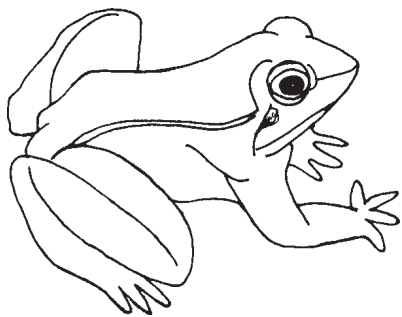

In this topic students observe some common small and large animals. You may select particular animals which are found in your local environment, or animals of folk cultural, religious, mythological or social interest, or some that might hold fascination for your children for any other reason. If occasionally you come across pictures and information on exotic animals like

tigers or whales, or if students have a chance to visit a zoo or a sanctuary or watch a nature program, then you might take up these more unusual animals for discussion and activities.

Here is a list of familiar animals to select from: dog, cat, goat, sheep, cow, buffalo, squirrel, mouse, monkey, elephant, sparrow, crow, hen, pigeon, parakeet, myna, bulbul, lizard, chameleon, snake, frog, fish, snail, clam, earthworm, leech, crab, prawn, lice, scorpion, spider, millipede, caterpillar, fly, flea, mosquito, butterfly, bee, ant, cockroach, termite, grain-weevil, grasshopper, cricket, firefly, dragonfly, bedbug, ladybug, beetle ...

As in the other topics, these questions and activities should stimulate students to go back to their environment and observe closely. Some questions may be answerable from previous experience while others would need further observations.

Watch out for animals!

Activity 6.1: Observe these two animals. Notice the differences between them. Notice also the similarities.

This exercise will arouse students' curiosity and initiate them into observing and thinking about animals. Choose any two familiar and somewhat similar animals for comparison, say a dog and a cow, a sparrow and a pigeon, or a bee and an ant. Wherever feasible this exercise should be done with the animals actually present in front of the children.

General questions to be asked about any specific animal:

Where have you seen (this animal)? What have you seen it doing?

Children observe animals in the neighbourhood more closely than we adults do. You might be surprised at the things they notice!

What is the colour of the animal? How big is it? Does it have hair? Does it have feathers or scales? How many legs? Horns? (Especially for birds and insects) does it have wings? How many?

Where does it live? Does it make its own house?

What food does it eat? Does any other animal eat this animal?

What do you like or dislike about this animal?

Have you seen the young one of this animal? What is it called (in case it has a special name)?

Activity 6.2: *Act like this animal. Move like it and make the same sounds that it makes.*

The class might act out a story or poem containing one or several animals.

Activity 6.3: *Make a model of this animal using materials from your surroundings.*

Some ideas for making models are given later for specific animals.

Blackboard work: *Tail the donkey.*

Draw a large picture of an animal on the blackboard, the animal missing one body part, as in a donkey without a tail. Students will take turns to be blindfolded and try to draw the tail of the donkey ... or ears of a rabbit ... or horns of a cow ... or tail of a peacock ...

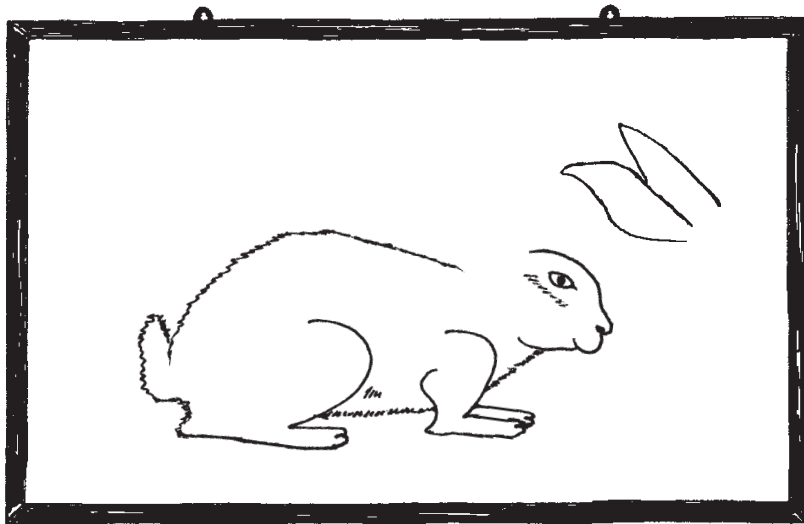

Dogs

Do you like dogs? Or are you afraid of them? They will not do you any harm if you do not harm them ... but keep away from unknown stray dogs and guard dogs!

Which different kinds of dogs have you seen? Describe different types, their colours, sizes, hair, tail, ears, etc.

If you have a pet dog at home, tell the class about it - its name, what it eats, how it plays, etc. If you have stray dogs in your neighbourhood tell the class about them.

What foods does your dog like best, what foods does it never eat? What foods do dogs eat but we cannot?

Describe a dog's teeth - how are they different from ours?

When have you seen a dog wagging its tail, putting its tail between its feet, using the tail for anything else?

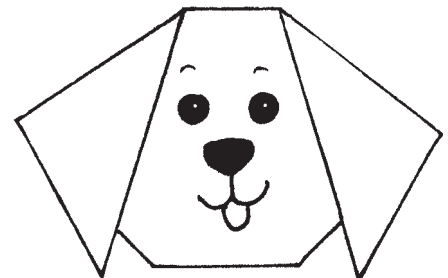

Activity 6.4: *Imitate different actions of a dog in various situations.*

Have you seen dogs fall sick or hurt themselves - how do they take care of themselves? In a way different from us? Do dogs take care of other dogs? Have you heard of doctors for animals?

Snakes

Snakes may not be familiar animals but they are often well-known through myth, legend, ritual and via "snake charmers". Students are usually curious to find out more about snakes.

Have you seen a snake? Where? ... etc. Do you know that there are many different kinds of snakes?



Do you like snakes? Are you afraid of them? Why?

Activity 6.5: *Make a drawing of a snake and colour it.*

Show pictures of snakes to give an idea of colours and patterns.

Activity 6.6: *Make a model of a snake. You might use modelling clay (plasticine), or wire, or cloth, or you may start with two thin long strips of paper and fold them into each-other.*

A paper model of a cobra is shown.

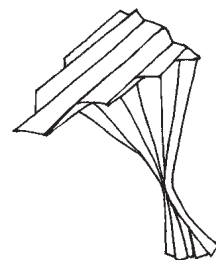
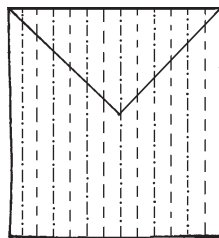
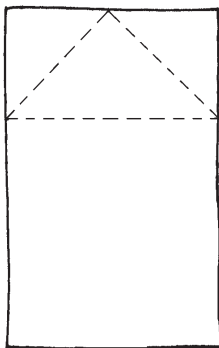

Act like a snake. Show how the snake moves. Do snakes make any sound? What sound do they make?

Does a snake have legs or arms?

Snakes have no legs, yet they can move very fast; they have no arms, yet most snakes can climb trees!

Where do snakes live? Does a snake make its own hole?

Snakes cannot dig. They live inside rock crevices or unused ant mounds, or in tunnels made by rats or other burrowing animals.

What do snakes eat?

Snakes eat small animals like mice, frogs and small birds. They can open their mouths wide and swallow animals that might be four or five times the size of their own head! Snakes smell with the help of their tongue.

Do all snakes bite? What happens if a snake bites us? What will you do if a snake bites someone?

The snake might be poisonous, so get help immediately! The injured person should lie down and try not to move; (s)he should be carried or transported to the nearest hospital. In the meanwhile tie a piece of cloth tightly on the part above the wound so that the poison does not flow to other parts of the body. Loosen the cloth periodically to let blood flow.

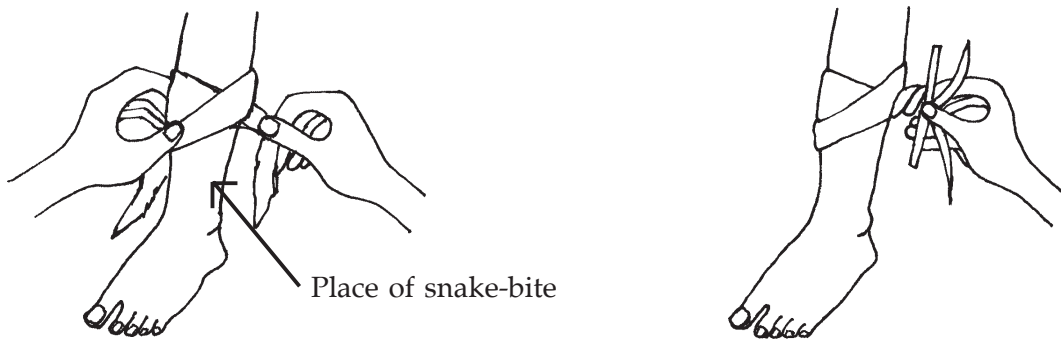

If snake-bites are common in the locality then these instructions would need to be more elaborate, especially for older students. Tying of a cloth tourniquet should also be demonstrated.

Snakes are useful to us! They eat mice which eat our crops and foodgrains.

Some common misconceptions about snakes

1. Snakes drink milk. (No!)

Snakes never drink milk. Snakes cannot digest milk. If they are forced to drink milk they could die of a stomach-upset. Out of sheer ignorance a very cruel practice is prevalent during the festival of *Nagpanchami*: snakes, especially cobras, are captured and milk is force-fed to them. This practice should be stopped.

2. Snakes bite to take revenge. (No!)

Snakes do bite us, but out of fear - not to take revenge for any past deeds! If you are in an area with snakes it is best to carry a stick, banging it on the ground to warn snakes you are there, so that they will keep out of your path.

3. All snakes are poisonous. (No!)

Most kinds of snakes are not poisonous.

4. Snakes inject poison through their tongue. (No!)

Poisonous snakes have two big teeth or fangs in the front of their jaws. These teeth are hollow and are connected to glands filled with poison. Non-poisonous snakes do not have these fangs.

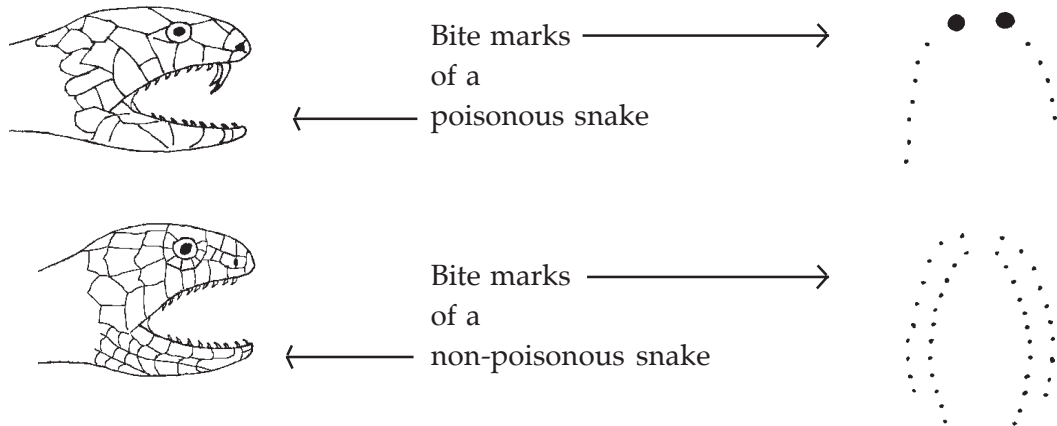

5. Snakes have many heads. (No!)

In stories and legends you might have heard of snakes with many heads. You might also have seen such snakes in fantasy programs on TV. Such snakes do not exist in reality!

6. Snakes dance to music. (No!)

Snakes do not have ears, so they cannot hear music. But they can feel the vibrations on the ground. They do move to the movements of any object in front of them (stick, cloth, *been* ...) that the snake charmer or *sapera* moves.

Birds

General questions on birds:

Activity 6.7: Watch for birds in your surroundings. They might be free birds or birds which are kept on a farm or as pets. Do you think any bird would like to live in a cage?

Which birds have you seen? Which birds do you know?

Activity 6.8: Observe any two birds. Notice the differences between them. Notice also the similarities.

How many legs do birds have? Wings? What body parts do birds have but we do not? (feathers, wings, beak, tail) What body parts do we have that birds do not? (hair, nose ...) What body parts do we have in common with birds?

Do all birds have similar beaks? Do they chew their food, do they have teeth?

Have you seen the nest of a bird? Where? Have you seen eggs of birds? Baby birds? Where? Do they look like the parent birds? Can they fly?

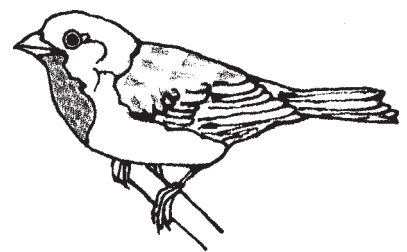

Activity 6.9: Collect feathers of birds, pieces of eggshell and old unused nests. Try to guess which birds they belong to.

Never disturb a nest which is being used by a bird! Never steal eggs from a nest!

Have you or anyone you know taken care of a bird in trouble? How?

Activity 6.10: Bring from home two halves of an eggshell. Make a small chick - out of paper or some other material - to put inside your egg.

Some birds that you know

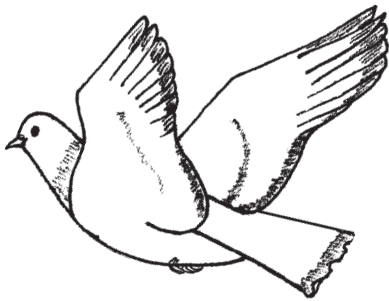

What is the colour of (this bird)? Is it the same colour all over the body? Any coloured patterns? What is the colour of the legs and beak? Is the beak short or long, blunt or pointed, straight or curved?

Does it walk? How?

The hen moves its neck back and forth at each step, the sparrow hops ...

Does it fly? How?

Flapping its wings rapidly or slowly, noisily or silently, soaring high, gliding ...

What food does it eat? Does it carry food in its claws or its beak? Show how it eats.

Have you ever fed this bird?

Some birds eat grains and fruit, some eat insects or larger animals, some eat only dead animals. Some small birds like sunbirds drink the nectar of flowers. Swifts feed on insects while flying. Sparrows and hens pick up foodgrains with their beak, a crow holds its food under its claws and tears it with the beak, bee-eaters sit on a high wire and make short flights to catch flying insects ...

What sound does this bird make? Imitate the sound.

Do you see or hear this bird always? Do you hear its sound only at some times of the day? Or during a particular season?

Do you usually see this bird singly, in pairs, in small or in large groups?

Do you know where it stays? Where does it build its nest?

Have you seen it building a nest? How does it carry the nest materials?

How does the nest look? What is it made of? Is it different from nests of other birds you know?

Activity 6.11: Collect material like grass, twigs, cotton-wool and feathers. Use them to make a nest of your own. You might try to make a nest exactly like one made by a bird, using the same materials that the bird used. You might put your model eggs of Activity 6.10 inside the nest.

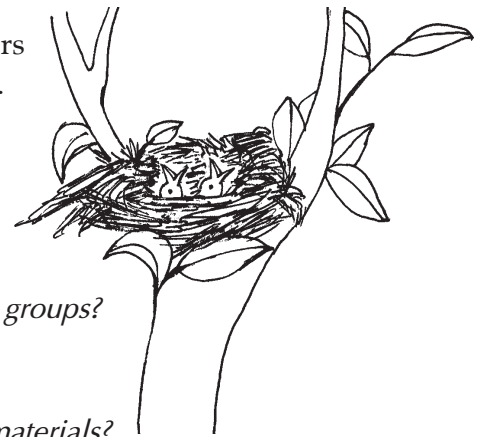

Ants

Activity 6.12: *Select a garden or a yard. Put some jaggery, nuts or fried food (any sweet or oily food) in a place where ants could be expected - say near an ant hill. You might also do this activity indoors where ants might be wandering. See how quickly one ant and soon many ants find the food and start to carry it to their home. Watch the ants closely. Be careful they do not climb up your legs and bite you!*

Watch for lines of ants. What do you see them carrying?

Ants carry dead insects or their body parts, sweet foods, seeds ... occasionally you may see a group of ants moving house, carrying identical white eggs and babies in their mouths. You might see a single ant carrying a piece of food or a group of ants together hauling a large piece of food. An ant can carry things 50 times its own body weight!

See *Small Science Class 3: TextBook* pages 16-17, *WorkBook* page 23 and *Teacher's Book* pages 64-65 for more information on this activity.

Have you seen ants of different sizes and colours, or ants with wings? Describe the types of ants you have seen. Do you know if all of them bite?

Where do ants live?

Ant homes may look like a small hillock, or they might be completely under the ground; they might even be located inside the walls of your own house! The ant home is like a palace with many passages and rooms. There is a queen ant, worker ants and drones. The queen ant stays indoors and lays eggs from which young ants come out. The worker ants take care of the queen and young ants - they find and bring food, they build and repair the home, keep it clean and guard it by biting intruders.

Have you been bitten by an ant? Describe how it feels.

Ants use their jaws to cut the food and carry it, and also to attack intruders - ants bite with their strong jaws.

How many legs does an ant have?

All insects have six legs - three pairs. Ants also have small feelers which help them find food and communicate, or "talk" with each other.

Activity 6.13: *Draw an ant. Draw a line of ants carrying food.*

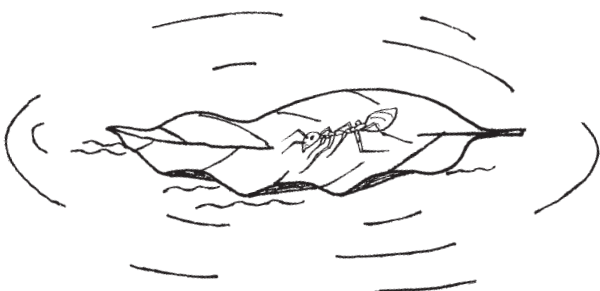

Find a story or legend about ants - example, the ant and the pigeon - ant drowning in water - pigeon sees and drops a leaf - ant climbs on it and is saved - some days later, ant sees a hunter aiming gun at the pigeon - bites him - he loses aim - pigeon flies off hearing the sound and is thus saved in turn. Another example is the story of the ant and the grasshopper.

Some other insects

Imitate the sounds made by a honey bee, a bumble bee, a mosquito, a fruit fly, a cricket.

Bees, mosquitoes and flies make buzzing or whining sounds by flapping their wings rapidly. Crickets rub their wings against their legs to make loud scraping sounds.

Activity 6.14: *Make a terrarium.*

See *Small Science Class 3 Teacher's Book*, pages 68 to 72.

Activity 6.15: *Catch a cockroach, keep it in a glass jar and observe it. Watch how it moves and what it eats. Try to catch a mosquito or a fly and observe it in the same way.*

Activity 6.16: *Find a caterpillar. Keep it in a box with holes. Feed it every day with fresh leaves from the plant on which you found it. Watch for some surprising things to happen!*

Activity 6.17: *Fold a piece of paper into half. Draw half of a butterfly on the side where the paper is folded. Tear carefully along the outline of the wings. Open the fold and you have the complete butterfly. Make it colourful by sticking bits of paper in different colours in a collage.*

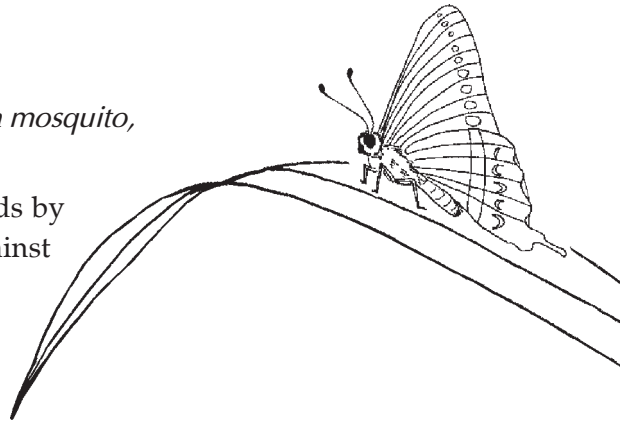

Animals that live in water

Students should carry out observations of any water animals that might be found in the locality like, fish, frogs, crabs, snails, clams, etc. Particularly in the monsoon season even in inland areas there are marshes, puddles and ponds where water animals are easy to find. See *Small Science Class 4 Teacher's Book*, pages 202 to 219. Books and films on exotic undersea animals might also be available.

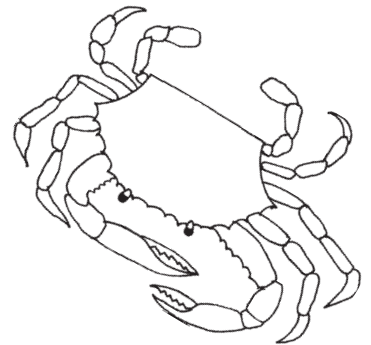

Activity 6.18: *Take some water from a pond and keep it in a glass bowl on a window sill. Watch what happens over several days.*

You may see some tiny floating plants in the water. Chances are that a mosquito will lay its eggs in the water and students will be able to watch tiny larvae and pupas of mosquitoes. See the story in *Small Science Class 4 TextBook*, page 56.

Find out why mosquitoes are dangerous to us.

When some types of mosquitoes bite us, we get terrible diseases like malaria, filaria, dengue and Japanese encephalitis.

Find out what we can do to stop the increase of mosquitoes.

Mosquitoes lay eggs in stagnant water. So do not allow water to collect in puddles and ditches! Keep storage water and sewers covered. In large ponds keep frogs and fish that eat up larvae and pupas of mosquitoes.



UNIT 3

OUR FOOD

7. Foodgrains
8. Vegetables
9. Fruits
10. Food from animals

7. FOODGRAINS

The aim of this section is to stimulate curiosity about the large variety of foodgrains, vegetables, fruits and meats eaten by people. Cleanliness of food is also emphasised.

Children in classes 1 and 2 are likely to have been exposed to only a limited number of foodstuffs. Our typical diets may be restricted by availability, taste, fashion, custom or dogma. In our varied culture there also exist misunderstandings and negative attitudes among different groups of people about diets of other communities. Discussions suggested here should help students become more aware, informed, interested and open-minded about food.

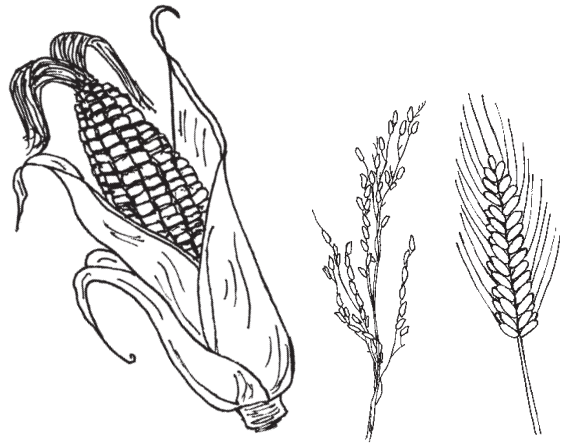

Open-minded yes, but teachers may notice that there is no mention here of commercially processed, packaged and "fast" foods. This deliberate omission comes from a judgement of desirability from a health, environmental and economic perspective. If the topic of processed foods does come up, please discuss it in the local context but do not fail to endorse the superiority of fresh foods in our everyday diet.

The greater part of our diet is normally made up from foodgrains, after which come vegetables, fruits and meats. That is therefore the order in which these topics have been discussed here. It may be better however, in actual teaching, to introduce foods with the simple and familiar topic of "fruits" (Topic 9, page 52).

Cereals

A few days before starting the topic ask students to collect different kinds of cereals like, rice, wheat, *jowar*, *bajra*, *ragi* or *nachani*, corn or maize, barley, oats. Introduce the word "cereals" at the time of giving these instructions. The discussion below assumes that student have brought these cereals to the class and have also found out some of their names.

Include in the samples some whole grains of rice or wheat with the seed cover still on them They will be useful for the planting activity. If possible also bring leaves and ears of cereals, or even a whole plant.

How many of you have eaten these - rice, chapati, roti, phulka, bread, pav, bhakri, makki-ki-roti, mudda, naan, paratha, puri, ghavana, amboli, pulav, khichdi ...?

Ask this question for local staple cereal food item. Write 3 or 4 familiar names in one column on the left of the blackboard.

Do you know what each of these is made of? Like, chapati is made from wheat (flour).

Go through the names on the left, writing on the right of the board the corresponding list of cereals. Collect the samples of cereals brought by students. A few grains of each cereal can be given to each child.

How do these cereals look?

Students describe the appearance, colour, shape and (comparative) grain-size of each of the cereals. Sample responses -

Grain	Colour	Shape
Wheat	yellow, light brown, golden	Oval, has a line
Bajra	grey, yellow tip	triangle
Jowar	yellow, black tip	like Bajra, but larger
Maize	yellow, white tip	like Bajra, larger still

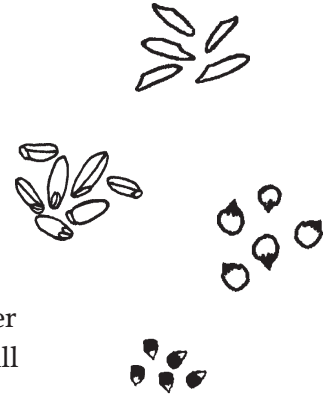

Activity 7.1: *Close your eyes and guess the cereals by touch.*

Activity 7.2: *Have you seen the plants on which these cereals grow? Let's plant these whole grains and see.*

The sprouting seeds and plants will have to be watered daily for several weeks. If possible a full-grown plant of any cereal should also be shown to the students.

All cereal plants are types of grasses!

This observation would be an outcome of the planting activity.

Observe the leaves and "ears" of some common grasses and the "ears" of some cereals.

In these ears, observe that the grains are seeds in fruits, one in each.

Can you eat cereals raw?

They are hard, do not have much taste. Your stomach may ache if you eat too much of raw foodgrains.

Find out some more things cooked from cereals - try to name the cereals used.

upma or uppita, halwa or sheera, dosa, idli, uttapam, appam (from Tamilnadu, Kerala, etc.), mudda or mudde (from Andhra and Karnataka - balls made from bajra and ragi flour), khakra, thepla (from Gujarat) thalipeeth, pohe (from Maharashtra), noodles, popcorn, kurmure, macaroni, spaghetti, pizza, cornflakes, cake, kheer, porridge ... ragi and barley are used to prepare malt. Some of these preparations contain pulses too.



*At every meal do you eat at least one thing cooked from a cereal?
Is there any meal at which you do not eat ANYTHING made out of a cereal?*

Cereals are necessary for us to live. They give us energy.

It is important to have some cooked cereal at every meal!

Exceptions might be meals with a tuber starch like sago, cassava or potato. Tuber starches are staple food in parts of Kerala and in areas of Africa.

Activity 7.3: Make dough models

Ask students to bring a small quantity of any flour (preferably wheat). Make a dough out of this flour and use it as clay for modelling. Steamed rice flour may be used instead of wheat flour. A variety of models were made by students using moulded dough - Snake, faces (of family members), cup, *diya*, mango, ice-cream cone, house, spectacles, bird's nest, bangles, doll, penguin, *modak*, temple, rolling board and pin, tree, sun ...

Pulses

As done in the case of cereals, a few days in advance ask students to collect different kinds of pulses like, *arhar* or *tuar*, *udad*, *moong* or *mug*, *chana*, *groundnuts*, *masoor*, *math* or *matki*, *chavli*, *vaal*, *soyabean*, *rajma*, *matar* or *vatana*. Students may bring whole pulses or split pulses (*dals*). Introduce the word "pulses" at the time of giving these instructions.

If possible also bring leaves and pods of pulses, or even a whole plant. Groundnut pods may be easy to find, as also some pods and beans which are eaten tender like, peas, *vaal*, *chavli* or french beans.

Which of these things do you eat - dal, sambhar, rasam, varan, amti or kattu or sharu, usal ... ?

Use names of local staple pulse food items. Write these names in one column on the left of the blackboard.

Do you know which pulses these foods are made of?

Go through the list of foods on the left, writing on the right of the board the corresponding names of pulses.

List some more pulses.

Collect the samples of pulses brought by students. Give a few grains of each of these pulses to each student.

Activity 7.4: *Close your eyes and guess the pulses just by touch.*

Activity 7.5: *Carefully rub a few grains of the whole pulse between two flat, slightly rough surfaces, say your desk and a ruler. Look at what is hidden under the skin of the pulse.*

Students may find this task a little difficult to do - they might end up crushing the whole seed. With luck and careful handling they might observe that when the covering of the seed is removed it gets divided into two halves, each of which is called *dal* - *dals* are made from fully ripened and dried pulses.

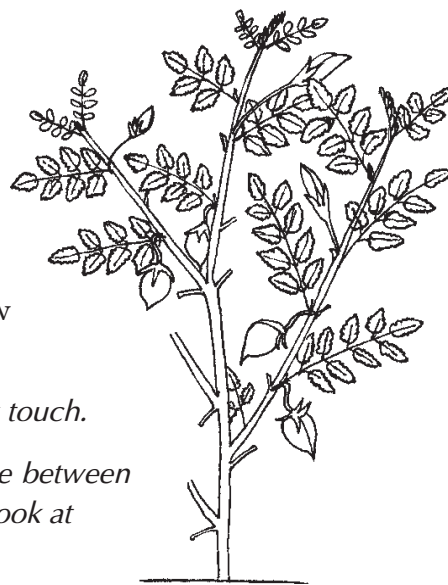

How do these pulses look?

Describe their appearance, colour, relative grain-size, etc.

Sample response -

"Moong is oval and rolls on the desk.",

After removing the skin and showing the *moong dal* -

"It is green from outside, yellow from inside."

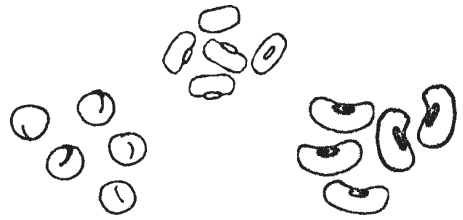

Activity 7.6: *Have you seen the plants on which these pulses grow? Let's plant some whole pulses and see.*

Water the seeds regularly. Notice that before sprouting the pulse grain swells up, its cover splits open and the two halves turn green.

Are the pulse plants grasses like the cereals or different? Let's find out.

If possible also show a twig and a pod of a pulse.

Will the dals also grow into plants?

Try it and see

Find out some other things cooked from pulses.

List local pulse dishes. Some regional possibilities are, *dhokla, idli, dosa, vada, dhirda* or *cheel, undhiyo, dalvada, bhajia, gujjia, puranpoli, chakli, papad, bari* or *badiyan* (used to make curry), *pessarattu* (moong dosa), *halwa* (moong, udad), *phutane*, sweets like *sone-papadi* and *mysore-pak* ...

At every meal do you eat at least one thing cooked from a pulse?

Some non-vegetarian or milk meals (breakfast) may be exceptional.

It is important to have cooked pulses every day!

Pulses make us strong and help us grow. They also repair worn-out parts of our body - this last idea is rather difficult for children to visualise.

Some of our other foods like, milk, egg, meat and fish also give us strength and help us grow. Still, our body always needs pulses.

Activity 7.7: *Stick various foodgrains on paper. Make designs, or simply write the names of the foodgrains in front of them.*

New words

cereals, pulses

8. VEGETABLES

A visit to the market before taking up this topic, either with parents or along with the class would make the students aware of the different varieties of vegetables. Refer to Topic 12, page 63-64 for more activities related to vegetables.



Vegetable variety

Which vegetables do you know? Which of these are leafy vegetables?

Write these names on the blackboard. Ask students to count the names in the list.

How many of these vegetables do you remember having eaten? Count again.

Choose a few local vegetables, keeping in mind variety in colour, size, shape, taste and use in cooking. Example of a list: tomato, beetroot, potato, drumstick, beans, cabbage, chilli, onion. You might also make a tabular form on the blackboard with a few column headings selected from those suggested below.

Describe some of these common vegetables as follows:

 "Name" of the vegetable

 "Varieties" of the same vegetable (based on colour, size, taste ...)

 "Taste": how does it taste when raw (if it can be eaten raw), or when cooked?

 "Touch" (soft, hard, rough, smooth, spiny or hairy)

 "Skin" (thick or thin; does it have to be removed while cooking)

 Food preparations or "Dishes" - what sabjis and other dishes can you make with this vegetable? What spices are added to it while cooking?

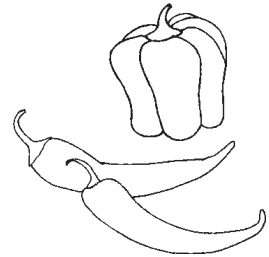

What is the colour of the vegetable? Describe its shape - round, oval, long, like a cone, irregular, with a stem ... Is it soft or hard? Does it have some smell? Does it have seeds inside?

Do you know that some vegetables grow under the ground? Can you find out one such vegetable?

Yummy veggies

At home, watch and help when vegetables are prepared and cooked. What is the first thing that we need to do before the vegetable is cooked?

Washing: hard vegetables should be scrubbed; soft vegetables should be washed gently but thoroughly.

Why should the vegetables be washed?

To remove dirt, germs and chemicals on them. These often cannot be seen but they make us sick if we eat them.



Peeling: which vegetables need to be peeled? What tools are used for peeling? Is it difficult to peel the skin of some vegetables? Can we eat some vegetables with the skin?

Cutting, chopping, grating etc: vegetables could be cut into different shapes and sizes. What are the tools used for cutting?

Cooking makes food tastier and easy to digest. It kills germs.

Different ways of cooking vegetables: boiling, frying, steaming, roasting ... Processes of grinding, mixing, mashing, stuffing ...

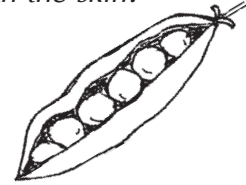

Children may know some implements used in cooking: stove, vessels of different kinds for storing and cooking, ladles or spoons, grinding stones, pounding mortar, mixer - grinder, oven ...

Activity 8.1: *Eating vegetables keeps you healthy (you won't fall ill often). Eating all vegetables is a very good habit - let us see which of you like to eat many kinds of vegetables.*

Name the vegetables one by one. Students draw an icon like a smiley 😊 on a paper if they like it and draw a different icon ☹️ or leave a blank if they dislike it. Or write a numbered list of a few vegetables on the blackboard for students to copy and make their icons.

Activity 8.2: *Vegetable printing*

Vegetables like lady's finger (*bhindi*), french beans, potatoes and onions can be used for block printing on paper using water colours. While some vegetables like *bhindi* have their own distinct patterns, some others like potatoes are good with cut-out patterns. Beet has its own colour which is adequate for printing on paper.

Students' Drawings

cauliflower

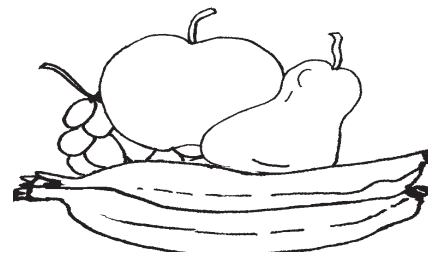

Lady's finger



Curry Leaves

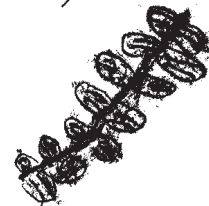

9. FRUITS

A fruity snack

Ask each student to bring to class one small fruit or a piece of a larger fruit. Tell them that at the end of the class, the fruits will be shared among the whole class. Collect the fruits - ask each student to name their fruit as they put it into the class collection.

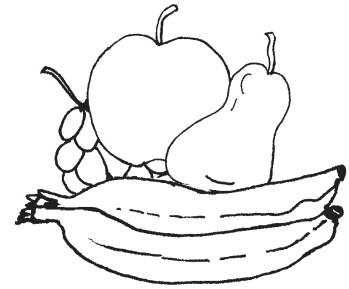

What are the names of these fruits?

Write all or perhaps only the simpler of the names on the board and ask students to read the list. Since there would be only a few names, this task should not be difficult. Many students may "read" the names only approximately, or simply guess from the length of the word or by recognition of a pattern.

Sort the fruits (keep those of one type together). Count the number of types of fruits.

Count how many of each type of fruit there are. Write this number on the blackboard next to the name of the fruit. Add these numbers to get the total number of fruits.

Arrange some selected fruits in a line, from largest to smallest.

Activity 9.1: *Some fruits are kept in a covered basket. One by one close your eyes, pick out a fruit and try to guess what it is with the help of smell and touch.*

Students may describe the size, weight, shape, texture and smell. More detailed questions, as suggested in the next section, may also be asked here.

Activity 9.2: *Pick up a fruit and wash it. Peel it (with some help) if necessary.*

You may cut the fruit and mix the pieces together into a fruit-salad which everyone can share. Add sugar if needed. Collect the seeds, wash and keep them for later observation.

Fruits of all kinds

Which different fruits do you know?

Depending on the level of literacy of the students, the entire list may be written on the blackboard, or only a few of the simpler words may be written. The students could be asked to read them and then count the total number.

Activity 9.3: *Fold a sheet of paper as shown on page 64. Draw and colour one kind of fruit in each box.*

Choose a few locally available fruits to make the following observations.

Name the fruit, describe its colour and shape if possible.

Fruits have a covering or skin on them, called a "peel". How is the peel to touch? Is it smooth, rough, spiny, hard or soft? Is the peel of the same colour as the inside of the fruit? Is the peel of the fruit eaten or not?

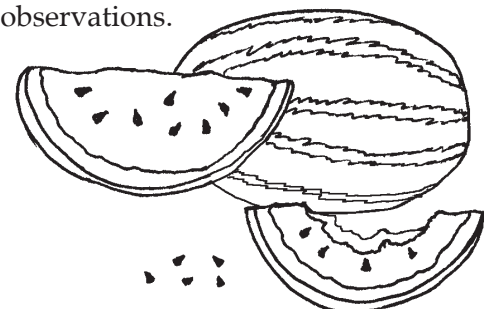

Can the peel be easily removed with the fingers or do you need a knife to do it?

How does the fruit taste? Is it sweet, sour, bitter or anything else? Is the fruit soft or hard or crunchy to chew? Is it juicy?

Does the fruit have seed(s)? How many (one, few, many)? What is their colour? Do you eat the seeds or throw them away?

The seeds of the jackfruit are cooked and eaten. Sometimes we do not remove the seeds of fruits like guava, pomegranate or tiny mangoes.

Do you see this fruit throughout the year or only in a particular season?

Some fruits may be preserved by drying, freezing or in some other way so that they are available all through the year.

Name some big fruits. Name some very small fruits.

Which is the largest of the fruits you know? Which is the smallest? Arrange the following groups of fruits from largest to smallest:

- mango, lemon, grape, watermelon
- papaya, jamun, jackfruit, orange
- apple, pumpkin, awla, pineapple

The sorting can be done with the names written on the blackboard or as given in the following Activity 9.4.

Activity 9.4: *Tear the paper on which you have drawn fruits, along the folds. You will have small cards with a fruit on each one.*

Students may sort these cards according to taste (or texture, juiciness, whether peel is eaten, number of seeds, etc.) and then count the number of fruits in each category. Ordering by size may also be done here.

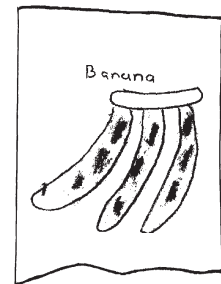

Student's Drawing

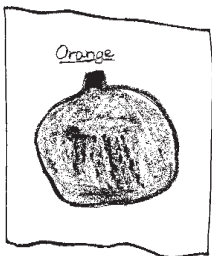

Student's Drawing

Which fruits can you eat cooked? Name some food items made from fruits.

Mango pulp or *aamras*, juice or squash or syrup (orange, sweetlime, pineapple ...), milkshake, jam, fruit salad (apple, mango, strawberry, chickoo ...), *muramba* or *murabba*, *chhunda*, pickle, *chutney* (raw mango, dates, *awla*, lemon), chips (banana and jackfruit), ice-cream (strawberry, lichi, custard apple ...), *shikran* (banana), *aam-papdi* (mango), *fanas-papdi* (jackfruit), *awla-supari* (*awla* or gooseberry), raisins (grapes), candies or confections ...

Have you seen some fruit when it is raw - how is it different from a ripe fruit?

What happens if a fruit is kept for many days or when it becomes too ripe?

Can you eat it then?

That is why some fruits are preserved by drying or freezing or adding salt or sugar to make pickles and *murabba*.

Activity 9.5: *Guess in which fruit this seed was found!*

Seeds collected from Activity 9.2 can be used here.

Name some fruits with big seeds. Name some fruits with white, black or brown seeds.

Arrange these seeds from biggest to smallest - lemon, mango, chickoo, banana ...

Make two groups of children. One group will describe a fruit or the seeds of a fruit and the other group will try to guess the fruit.

Activity 9.6: *Plant a seed.*

Seeds of some suitable fruits could be planted to see them germinating and growing into a tiny plant

If you plant a mango seed, which plant will you get?

Activity 9.7: *Collect some seeds, like those of custard apple, watermelon, chickoo. Draw a small circle on a flat surface. Hold the seeds together in your hands, shake them and throw them gently inside the circle. You are out if any seed goes out of the circle. Now with the forefinger drag the seeds one by one out of the circle, taking care not to disturb the others, else you will be out. If you have a mixture of different seeds, take out those of one type first and then similarly the others. The player with the most number of seeds wins, so count your seeds and find out the winner!*

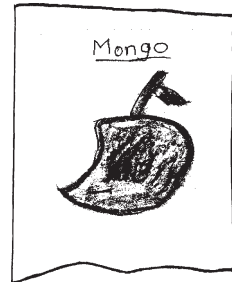

Student's
Drawing

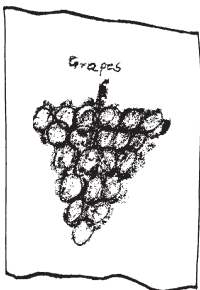

Student's
Drawing

Activity 9.8: *Find the favourite fruit.*

Choose any four names of common fruits. Write them down one below the other or draw a small picture of them. Ask some (about ten) people, which of these they like the most. For each person, draw a square in front of their choice or put a tick mark. Which fruit is the favourite choice among the people you asked and which is liked the least?

This can also be done for vegetables, flowers, plants, animals, vehicles ...

New words

peel, juicy, seasonal, raw, ripe.

10. FOOD FROM ANIMALS

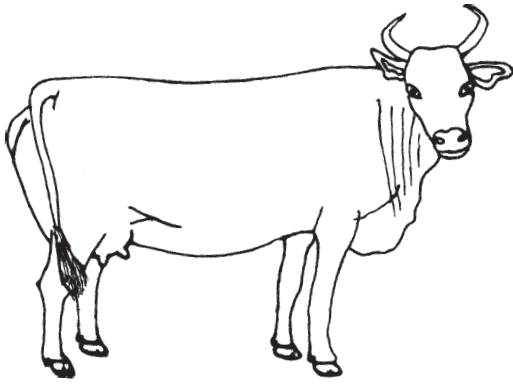

We have so far talked about foodgrains, vegetables and fruits. All these foods come from, "are produced by", plants. They are "plant products".

Do we get any foods from animals? Which foods are these?

Milk, eggs, meat, honey - these foods are "animal products".

Milk



Do you drink milk? Do you like to drink milk? Do you drink it hot or cold?

Milk is good food for children - it builds up your body, makes you grow tall and strong.

Does everyone in your house drink milk? If not milk then what else? Tea or coffee? Is milk put into it?

Where does milk come from? Which animals give us milk?

Cow, buffalo, goat, sometimes camel, yak, llama, ass ...

Which foods are made from milk?

Curd or yoghurt, *lassi*, buttermilk, butter, ghee, *paneer*, cheese, *khoya* or *mawa* or *khawa*, *kharwas*, *shrikhand*, sweets like *pedha*, *barfi*, *sandesh*, *rasagolla*, ice cream, milkshakes, chocolates ...

Activity 10.1: *Bring some milk or milk food to class.*

Do you have in your home any animals from whom you get milk? Which animals? Is this milk sold to anyone?

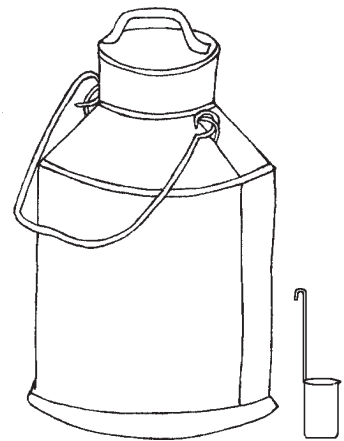

Students in rural areas may have experiences of keeping milch (milk-giving) cattle. They may also know how a quantity of milk is measured. For semi-urban and urban areas the next few questions would be more relevant.

Do you go somewhere to buy milk or does someone deliver milk to your house? Where do they get the milk from?

Have you seen a milk delivery van? Have you seen milk tankers on trucks or trains?

In what way is the milk packed? Is it sold loose or in bottles or plastic sachets or tetrapaks?

If sold loose, how does the milk delivery person measure it out?

Find out - how much milk does a bottle, sachet or tetrapak hold?

Guess - how much milk do you think a tanker might hold?

Many thousands of litres! Around 2000 to 8000 litres.

Do you need to buy milk every day? Could you buy milk and store it for a week (as you may do for foodgrains)? Why or why not?

When you buy milk from a shop does it feel cold? How has it been kept cold? What would happen if it remained warm?

Activity 10.2: *Draw the containers and measuring cups, bottles, sachets and so on used for delivering milk.*

Activity 10.3: *Collect milk bags or tetrapaks. Try to read what is written on them.*

Students may be able to read the quantity, the brand name, whether it is cow milk or buffalo milk or mixed; whole milk, low-fat or toned, etc.

Activity 10.4: *Two half litre make one whole litre. Draw and show how many half litre bags make up 1 litre, 2 litre ...*

Blackboard work: *How much milk?*

As an alternative to the previous activity, you may draw the milk bags and ask how many litres they make?

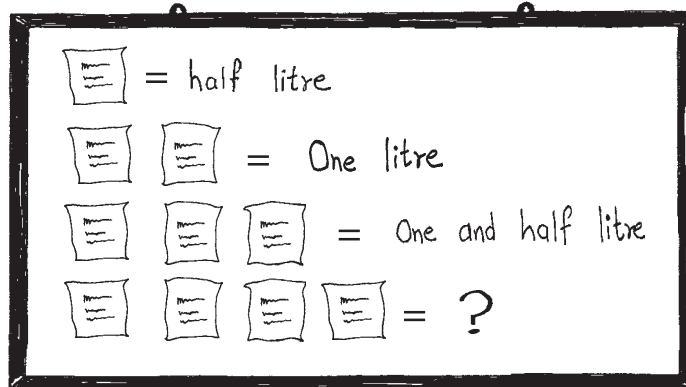

Eggs

Do you eat eggs? Do you like to eat eggs? Eggs too are good food for growing children.

Where do eggs come from?

Birds lay eggs. If a bird's egg is allowed to stay warm for a few days it will hatch and out of it will come a baby bird. You might have seen a hen sitting on her eggs to keep them warm. Eggs that we get in the market are usually of the kind that do not produce baby birds.

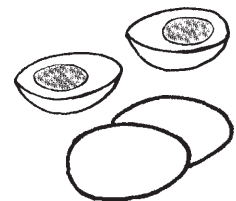

Other animals that lay eggs are, fish, amphibians like frogs and salamanders, and reptiles like snakes and lizards. Eggs of fish and frogs occur in bunches - each egg is very small. People who eat fish may also eat the eggs of fish, which are called "roe".

Eggs of which birds are eaten by us?

Hen, duck, goose, turkey ... eggs of some wild birds too are eaten.

Describe an egg - how does it look, etc.

From the outside - descriptions may include shape, colour, texture, hardness, brittleness.

How does the inside of an egg look?

Describe white of egg, yolk of egg.

How are eggs eaten - what food preparations are made from eggs?

boiled, scrambled, poached, fried, omelette, *bhurji*, egg *paratha*, egg french toast, egg curry ... eggs are also put in cakes, pastries, puddings ...

Have you seen how eggs are kept or stored in a shop?

In stacks using egg trays.

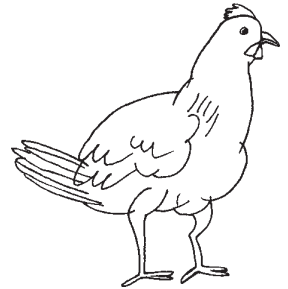

Activity 10.5: *Bring some egg trays and several stones or marbles. Make up some games using these.*

Put one stone in each compartment of the tray. How many stones are there in the tray? Now put two stones in each compartment. How many stones fit in the tray now?

How many eggs will fit in one tray? In two trays? In three trays? If there are two eggs less in the tray how many eggs are there?

Meat

Do you eat meat? Do you like to eat meat?

Some families and people are vegetarians. They do not eat meat or eggs.

Meat is good for growing children, but there are also many plant foods like dals, groundnut and sprouted pulses (also milk products) which help you grow big and strong.

Meat of which animals is eaten?

Chicken, goat, sheep, cow, buffalo, pigs, boar (wild pig) ... other wild animals are eaten by some tribal communities.



Just like some people are vegetarians, others because of their religious beliefs may not eat cow, buffalo or pig meat.

People often rear (take care of) animals which are useful. These animals give milk, eggs or meat. They are called "domestic animals". Domestic animals also include some that provide transport, like ox and horse, and protection or companionship, like dogs and cats.

Are some animals living in the water also eaten? Name some of these animals.

Fish, prawn, crab, lobster, shrimp, clam, oyster, octopus ...

Are only some types of fishes eaten? Can you name types of fish that are commonly eaten?

River fish like rohu, magur, hilsa, catla, mrigal, trout; sea fish like pomfret, halwa, surmai, eel, shark, bombil, bangda, tuna, also whales in some countries. Use local names of fishes.

How are fish caught from water? Have you seen a fish market?

Do you recognise the smell of fish?

In areas close to fishing communities or markets these questions could be more detailed.

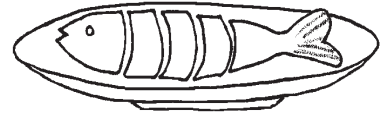

Activity 10.6: *Bring to class a meat or a fish bone or a crab shell which has been well washed and then dried in the sun for several days.*

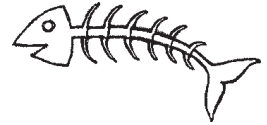

Honey



Have you eaten honey? Do you like honey? How does it taste? What is its colour?

Where does honey come from?

Honey is made by bees who collect the nectar from flowers and bring it back to the hive. The honey is food for bees in the hive. It is also useful in the winter or at times when there are fewer flowers.

Have you seen a hive (or honeycomb)?

Students might have seen beehives attached to trees or old buildings, or honeycombs - hives full of honey - for sale in the bazaar.

Have you seen the patterns on a honeycomb?

Draw the hexagonal patterns on the board.

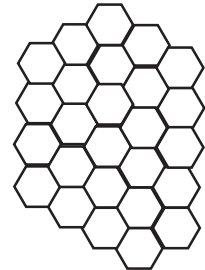

You may tell a story of a beehive - similar to the ant-hill, the beehive is like a palace. There is a queen bee, drones or princes, worker bees and young bees ...

How is honey eaten? What is honey eaten along with?

Honey may be part of some sweets, it may be had with milk, with some herbal medicines, with roti, in lemon juice ...

Activity 10.7: *Write the names of food items - different foodgrains, vegetables, fruits and animal products, on chits of paper. Fold the pieces and keep them in a bowl. Pick up one chit from the bowl and say whether this food comes from a plant or an animal.*

Activity 10.8: *Write the names of different domestic or food animals on the chits of paper.*

The teacher may call out "milk", "eggs", "meat", "four legs", "two legs", "wings" ... All those students having the appropriate animals raise their hands and tell the names of the animal.



UNIT 4

PEOPLE AND PLACES

11. Our school
12. Market
13. Letters, postman, post-office
14. Buses and bus stops
15. Trains and train stations
16. People at work

11. OUR SCHOOL

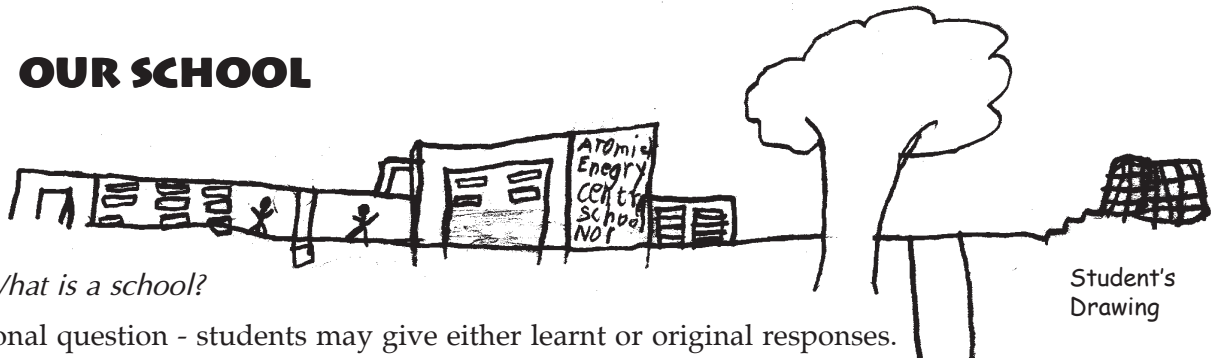

What is a school?

Optional question - students may give either learnt or original responses.

What is the name of our school?

Which other names of schools do you know? Have you seen any of these other schools or only heard of them?

Schools may be in a surrounding area or somewhere else. This will give an idea of the range of their experiences of schools. They may know of different types of schools like girls', boys', co-educational, boarding schools and *ashram shalas*.

Do your sisters/ brothers attend the same school as you or a different one?

Do you know any children around you who do not go to school? Why not? Do you think they should, or would like to, go to school?

Activity 11.1: *Draw a picture of your school. Show yourself, your school friends and others in the picture. Write down the name of the school.*

Activity 11.2: *Draw the way from your home to school. Show what you see along the way, like buildings and shops and also write their names. You may also draw trees or any other things that you see on the way.*

Counting time

Is your school close to, or far away from your house? How much time does it take you to reach there?

Do you walk or use some vehicle like, a cycle, scooter or bus, to come to school? Do you come on your own or with someone?

How do you know when the school has begun and when it has ended? Imitate the sound of your school bell.

Do you like school? Are you happy to come to school? Why? Are you happy when school ends and it is time to go home? Why?

At what time of the day does your school begin? Are you ever late for school? What happens then?

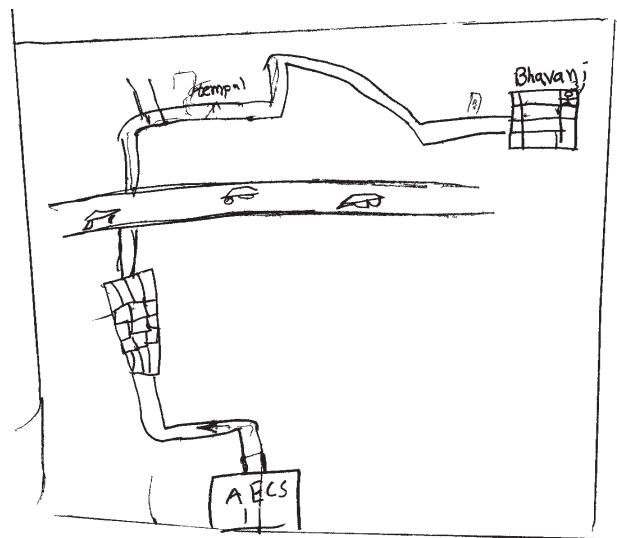

Student's Drawing

At what time does the school end? So how many hours do you spend in school? Is that a lot of time?

Students might try counting the hours forward on their fingers from the time of start of the school day. Explain that after 12:00 noon you get to 1:00 in the afternoon. If necessary ignore half-hours and round off to the nearest hour. Students' idea of "time of day" may be less or more developed depending on the educational background at their home.

Do you have a "half day" at school sometimes, when? At what time does the school end on that day? This is how much earlier than usual?

Do you have "periods" in school? How many periods do you have on a full day? On a "half day"?

The class time-table can be used for this discussion.

How do you know when a period or the recess is ended? Is this sound or ring different from the starting or ending bell?

On which days do you have holidays? (Sundays, festivals, etc.)

Count how many days are there in a week. On how many of these days do you come to school?

Describe the things that you do from the beginning to the end of a school day.

During school after how many periods do you have recess? Why do you have recess? What do you do then?

Learning in school

Which class are you in? What is the name of your class teacher? What are the different things (s)he does with you? Are there also other teachers who teach you?

Do you celebrate Teacher's day in your school? On which date is it celebrated? How?

Do you learn different subjects in school? Count how many subjects you learn.

Depending on the nature of the school, students may have different ideas about "subjects" that they learn.

Which subject or class do you like the most? Why? How many of you like " _____ " (a particular subject)? Count the number of students who have raised their hands in response. Is there any class that you do not like? Why?

What do you learn in school? Each of you name one thing that you have learnt in school, that you did not know before!

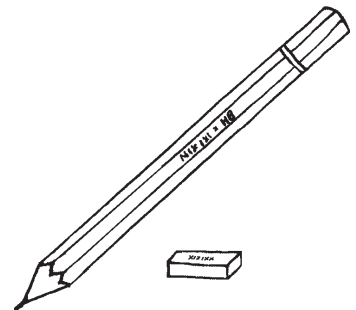

People and parts of the school

Who are all the people in your school? What do each of them do?

Introduce words like student, teacher, principal, head-teacher, clerk, peon, helper, gardener and also classmate, schoolmate ...

Activity 11.3: *Come to the front of the class and act like a teacher. Act like your Principal, or any other person in your school.*

What are the different places or rooms in your school?

Classrooms, office, staff room, library, display areas, playground, toilet, etc. A "treasure hunt" might be an interesting way to familiarise students with the different parts of the school.

! Take Care

If there is a kitchen in the school, it should be away from the classrooms. No flammable materials should be kept in or near the classrooms.

Which part of your school (premises) do you like the best? Why?

Activity 11.4: *Count and find out - How many classes and how many classrooms are there in your school? Does every class have a room? Are the classrooms large enough to hold all the students in that class?*

Activity 11.5: *Pretend that you have done something wrong, for example, you may have come to school late, or not done your homework. One of you be the student, another be the teacher and act out this scene. Then pretend that you have done something good, like doing your homework well (think of some other nice things)! Act out this scene too.*

Activity 11.6: *Count the number of students in your class. Each one of you write your name with a crayon in large letters on a sheet of paper or thin paper plate. Decorate the other side of the paper with a drawing or painting.*

You may help students with the writing. The papers or plates of all the students can be pasted along a string which can be tied overhead in the class.

New words

period, subject,
attendance,
classmate, schoolmate,
office, staff.

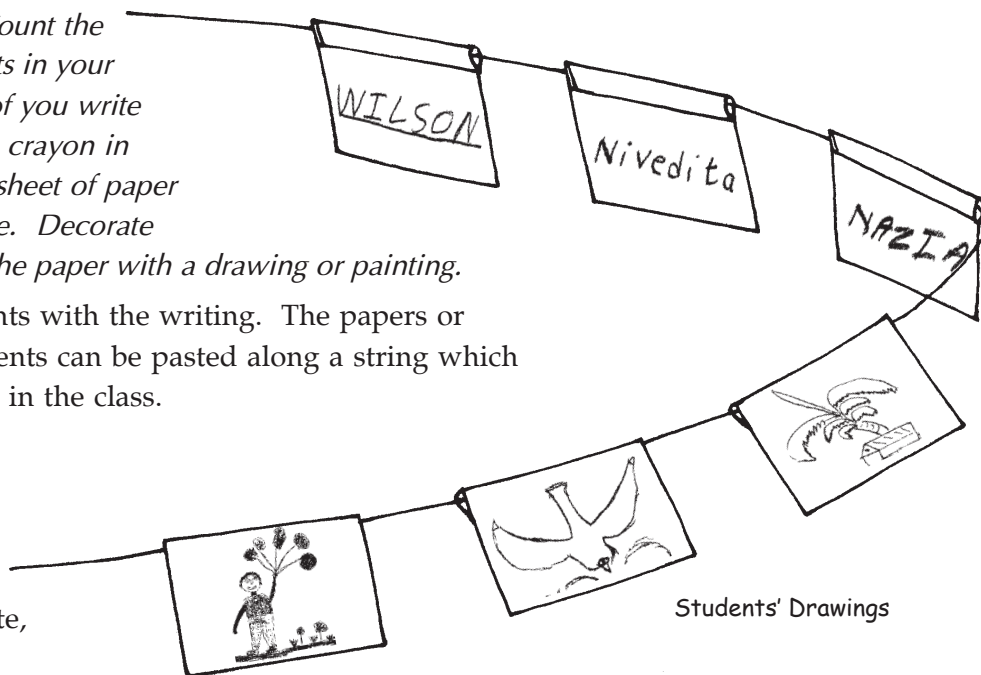

12. MARKET



Have you been to a market?

Have you ever been to a market? What do you do in a market? How often do you go to the market?

Use words like, regularly, often (many times), sometimes, rarely (few times) ...

When was the last time you went to a market?

Which different markets have you seen?

These are initial probes to gauge the range of students' experiences. Have they been to only one neighbourhood market or to several? Do they know about specialised markets? About markets that may be set up for a single day of the week - as a village market or on a few or on all days with an exceptional holiday?

What all have you seen in the market? What were the different people doing? Close your eyes and recall everything that you saw, heard or smelt.

Recall shops, vendors squatting or standing with baskets or hand-carts (*thela-walas*), calling out their wares and prices, people buying things, arguing over prices; smells, as those of vegetables, fruits, hay, leather ...

Imitate the calls of some roadside vendors. Do you like going to the market? Why or why not?

Do you go to the market alone or along with someone? With whom? Do you get some instructions (do older people tell you what you should do or not do) in the market?

Are markets crowded? Do you see more crowd sometimes, at which times of the day or week or year?

Morning or evening, holidays, festivals - give examples

Have you seen a market in any other place or in another part of your town or city? How was it different from the one in your area?

Have you seen some special markets, like fruit, flower, fish, cloth, metal, cattle markets? Find out about one such special market.

So now, we have talked so much about markets, can you tell me in one or two sentences, what is a market?

Students may need some help in construction of sentences like, "A market is a place where ..."

Greengrocer (A person selling vegetables)

Activity 12.1: Visit the market with your parents.

Alternatively, the class could be taken for a visit to the market. When students are taken for a visit it would be better to concentrate on only a few things, like vegetables and fruits. Some guidelines for observation should also be given, for example, notice different kinds of

vegetables and fruits; their names; what are they kept in? (in baskets or boxes made of cane, wood, cardboard or plastic of different colours, with or without straw (why straw?); any special arrangements; watch how customers ask for and select vegetables or fruit - by sight, touch, smell; do customers bring bags, does the vendor provide bags; how the vendor weighs or measures out the vegetables or fruits; exchange of money; arguing over price (bargaining) ...

Blackboard work: Which are the vegetables that you saw at the greengrocer's?



The names of vegetables are written on the blackboard in some natural categories.

Activity 12.2: Draw some vegetables or fruit that you saw in the market.

Activity 12.3: Fold a sheet of paper into 6 or 8 parts. Write the numerals 1, 2, 3 ... in one corner of each box. In each box, draw as many vegetables as the number, say 1 pumpkin, 2 bunches of spinach, 3 lady's fingers (bhindis) ...

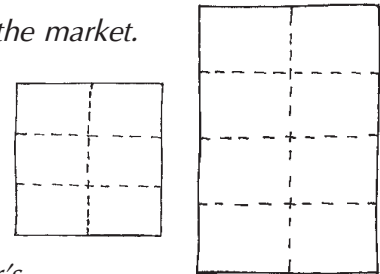

Describe how the vegetables were arranged at the greengrocer's.

In small shares or larger piles, spread on a sheet, in baskets, on a cart, arranged in steps ...

Does any vegetable seller come to your house? How does he or she bring vegetables? Customers got vegetables; what did they give to the greengrocer?

Money, notes, coins - some simple money-exchange activities may be done in class.

Do greengrocers sell the vegetables by number or weight or a fixed amount, i.e. a bundle or a share? Which vegetables are sold in these different ways?

These questions should be simplified using some examples of vegetables that are sold by number, weight or share.

How does the greengrocer weigh the vegetables? What does (s)he use?

How are the vegetables carried home? Does your mother or father bring a cloth bag from home? Are vegetables sold in paper or plastic bags? What is done with these bags later?

Do you know that we should avoid unnecessary use of plastics? Find out why we should use as few plastic bags as possible and what kind of bags we should use instead.

Plastic remains as it is, it does not decompose easily. Waste plastic bags create more garbage, clog drains and poison the soil. This poison may enter our water or food. When animals like cows and goats eat plastic they slowly get sick and die.

Shops

*What different types of shops have you seen?
Do all shops sell the same things?*

*How do you find out what things are sold in
some shop?*

From signboards, from things displayed outside
and inside, or in show-windows ...

Who are the people you see in the shop?

shopkeepers, helpers, salespersons, customers

*What things do you see in the shop? What things does the shopkeeper use? What are
these used for?*

Weighing balance, measuring tape, rate-board, notebook, bill or receipt book, pen, calculator ...



Does the shopkeeper sit in a particular place in the shop?

Where does (s)he keep the money that is given by customers?

*Travelling (door-to-door) salespersons: Does anyone come to
your house to sell some things? What things? Describe ... etc.*

Activity 12.4: Find the names of 1-2 shops near your house
and what they sell.

Activity 12.5: Collect old shop-bills from shops. Try to read
what is written on them.

Depending on the literacy level in the class, discuss what
things were written on the bill: the name or logo of the shop, address, what all is sold in it.
Select some bills where items bought are legible - what was bought, how much did it cost?

Activity 12.6: Act out a market scene. Some of you act as shopkeepers and others as
customers. The "shopkeepers" decide what is sold in the shops and a name for the shops.
The "customers" visit the shops.

Showing the items, choosing, bargaining, measuring, making bills and receipts, etc. can be
included wherever possible.

New words

shopkeeper, vendor, hawker, salesperson, customer, grocer, greengrocer, weighing balance,
measuring rod or tape, bill, receipt.

13. LETTERS, POSTMAN, POST-OFFICE

So far in this Unit we have seen how much children can learn by simply observing and engaging with their surrounding social institutions like the school and the market. Later we look at travel and means of transport as a context for learning. Somewhere between these two lie various forms of distance communication. Spoken and written communication modes include letters, telegrams, telephone, fax and the internet.

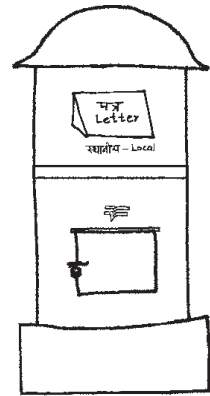

The postal service being widespread in our country, letters and postmen should be familiar to most students. A village post-office may be important in the child's world as the only place, apart from the school, which transacts business in written, rather than spoken mode. As always you should select topics appropriate to the experiences of your students.

Have you seen a postman (or postwoman)? Why does (s)he come to your house?

In towns and cities courier mail may also be common.

Activity 13.1: *Bring to class used post-cards, envelopes and inland or air-letters. Try to read what is written on their outside.*

*Look at the picture on the post-card or stamp.
Look at the cost written on it.*



Even the most common stamps have interesting pictures.

Students might also bring stamps with pictures of well-known people, places and things, or stamps from other countries with unusual pictures and their cost marked in foreign currencies. All these are opportunities to widen the child's experiential world.

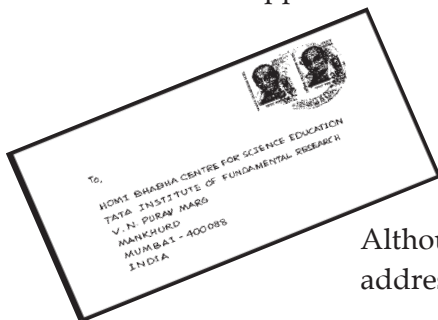

To whom was this letter sent? How did the postman know where to bring it?

What is an "address"? Tell me your address. Find out your "pin-code" and tell it to me.

Although student may not yet be able to write or even read their own address, if need arises they should know how to tell it to someone.

Who sent the letter? From where? The stamp-mark on the letter will show you where it came from.

Did the letter come from very far away? Do you think your postman might have brought it from that far away?



We will find out how letters get from one place to another.

Activity 13.2: *Bring some new post-cards, inland letters and envelopes along with postal stamps.*

On which part of these will you write your message? Where will you write the name and address of the person to whom you are sending the letter?

Where will you write your own name and address?

Which of these (cards, envelopes etc.) have a stamp printed on them? On which ones do you have to put a stamp?

Where will you affix the stamp? How will you stick it there?

What is the cost written on the post-card stamp?

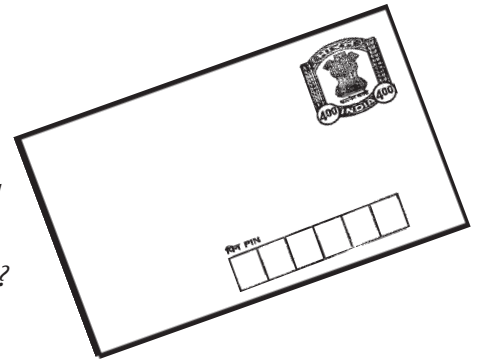

As of 2004, a post-card has a 50 paise stamp while an envelope must have a minimum 5 rupee stamp. A heavier letter needs more worth of stamps.

If I buy two stamps costing 5 rupees each, how many rupees will I have to pay?

If students know that one rupee is 100 paise, they may also be able to do some simple conversions with the cost of the stamp.

Suppose I have to affix a 5 rupee stamp on an envelope, but I have only 2 and 3 rupee stamps, what should I do?

Where do you get inland letters, postal envelopes, stamps, etc.?

Describe step-by-step everything you will do if you have to send a letter to a friend.

Activity 13.3: Write a letter on your postcard:

Give each student a new post-card or ask them to bring one from home. Ask them also to bring their address written in clear and legible form on a separate piece of paper.

In addition, they might bring the address of a friend or relative.

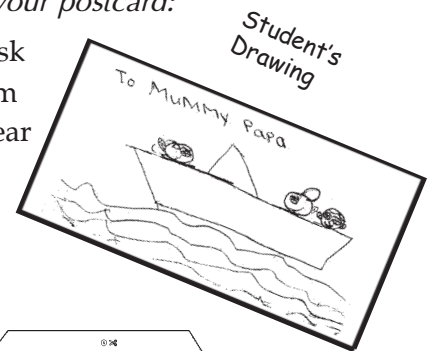
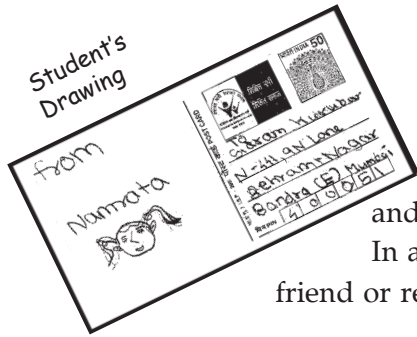

Copy your parents' or friend's address in the space after the "To".

Students might learn to use the prefixes Mr., Ms., Dr., etc..

Write a message on the post-card, or draw a picture.

A simple message or drawing will do. There is no need to follow any format.

Post the card in a post-box.

This activity may be done in combination with a visit to a post-office, Activity 13.5.

How does the post-box look, have you seen it? Describe its colour and shape.

In major places in cities you might find a green box for local and a red one for outstation letters.

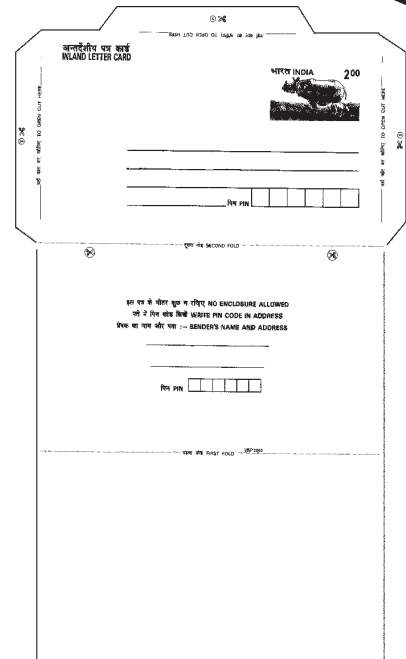

Here you should imagine and describe a simplified route taken by a typical letter to, or from, a place known to the students. You may begin by describing how every day a postman opens the locked door of the post-box, collects the letters, puts them in a bag and takes them to the nearby post office. Here the workers stamp (mark) the letters with the post-mark of that post-office and sort them according to where they have to be sent. The people who sort the letters need not read the whole address, just the pin-code is enough - for example, when they see the code _____ they know the letter should be sent to the _____ post office (please give the pin code of your area). The letters are then put into bags and taken by bicycle or van to the bus or train station ... they travel by train, airplane, bus ... and finally reach the _____ post office where they are stamped again. The postman at the final post-office brings the letter to the address written on it.

Have you seen a postman or postwoman? What does he or she wear? How does (s)he carry all the letters? Does (s)he walk to every house, go on bicycle, etc.?

You may invite local postal delivery persons to the school to demonstrate their equipment and talk with the students about their work.

Activity 13.4: Act out a scene in which you are a postman or postwoman.

Activity 13.5: Visit a post office.

Students may do some or any of the following things depending on their level of literacy:

- 1. Try to read the sign-board of the post-office including the full address and pin-code.*
- 2. Look at the boards showing timings and cost of different postal materials and services like stationery, money-order, telegrams, etc..*
- 3. Observe the counters for stamps and other postal materials like post-cards, money-order and postal order. Watch what people do at the counters.*
- 4. Find out the cost of a post-card or inland letter from the display board and buy one.*
- 5. Try to meet and talk with the post-master.*
- 6. Watch how letters and parcels are weighed and sorted.*
- 7. Look at the letter boxes, their colour and shape. Find out where we put in the letter and from where the postman takes it out. How can you tell at what time the letters will be taken out?*

After the visit students might also be told, in simple words, with examples, about registered post, speed post, book post, money order, telegram, parcels and postal savings. If courier services are common in the area you may explain this too.

New words

Letter, envelope, postcard, stamp, affix, address, receiver, sender, pin-code.

14. BUSES AND BUS STOPS

Children greatly enjoy riding on buses and trains. In this Unit therefore we deal with these two topics in some detail. Unit 6 includes general observations about various means of transport.

Buses are a common means of transport in cities and between towns and villages. They provide an excellent context for learning about places and people, besides developing skills of literacy and numeracy. Observation of the bus itself is part of Topic 21 and therefore is not repeated here. In preparation for the next two topics, please ask students to collect used bus and train tickets.

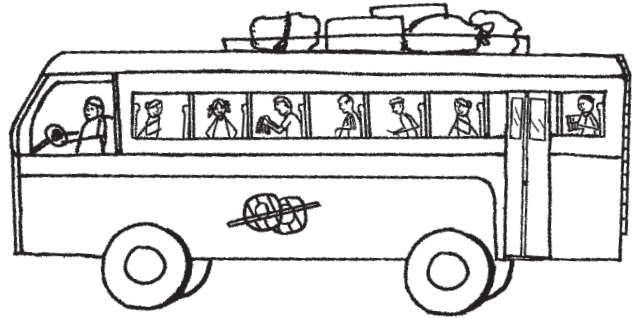

City, town and village

Do you live in a city, a town or a village? What is its name?

Have any of you been to a small town? To a village? To a city? Describe these. Think of any one difference between a city, a town and a village.

How do you travel from one part of your city, town or village to another part? How do you travel from your city, town or village to another one?

Ask these questions in relation to the places known to students.

Bus-stand, Bus, Conductor

Activity 14.1: Make a model bus using a shoe box or any other material. Run your bus along one or more roads drawn on the floor.

Have you travelled on a bus? Do you ride on a bus every day, many times, sometimes, or very few times?

This is another opportunity to introduce phrases like, "often", "once in a while", "rarely", etc..

Depending on where they live, students may have experiences of local and long-distance buses, public and private buses, or school buses. They may also have travelled in special buses going on a tour or picnic.

Students who have seen different kinds of buses should be able to recognise them from their distinctive colours and patterns. They may know the name of the local bus company or public bus service and read out acronyms like BEST, DTC, MTC, PMT, ST and so on. City buses are likely to have advertisements painted on them.

In big cities there are buses for travelling from one part of the city to another. Have you seen a double-decker bus?

In India some cities like Mumbai and Chandigarh have double-decker buses.

Have you seen a bus stop? What does it look like? Have you seen a bus depot? What is it?

In a small place the bus stop may be a locally known landmark like a temple or a tea-shop, it may be entirely unmarked, or it may have a bench with a shade or a pole. A city stop or a major depot may have a signboard listing the route numbers, with destinations and detailed routes of the buses stopping there.

Students may know that a particular bus visits their local stop at specific times of the day. City students should know about route numbers of buses, at least of those serving their own locality.

Do all the buses stopping at the stop go to the same place? How do you know where a bus is going? Where is the name of this place written?

There are many types of numbers written on buses. The route number and destination are written in specific places.

Have you waited for a bus at the bus stop or seen people waiting there? Do they stand in a queue? From which door do they enter the bus and get down from it?

Take Care

! *While getting into a bus make a neat queue. Never try to get in after the bus has started moving. Get down from the bus only after it stops, again in a queue.*

Do the driver and conductor wear a uniform? Of what colour? Have you seen a ticket checker at any bus stop?

How does the driver know when to stop and start the bus?



What does the conductor do? What things (tools) does he have with him? What does he do with these things?

Activity 14.2: *One of you act as a bus driver. Another will be a bus-conductor and give tickets to others who will act as passengers. A few of you may stand at a "bus-stop" in a queue and then get into the "bus" when it comes your way.*

Students may separately act out the scene inside the bus and on the bus-stop before doing the two in co-ordination. You might encourage the "bus conductor" to do various things like, ringing the bell to signal "stop" and "start", asking passengers for tickets, tearing out tickets from bundles, punching them before handing over to the passengers, accepting the money, putting it in a bag, returning the change, and so on.

Does the conductor give similar tickets to everyone?

Activity 14.3: *Look at the tickets you have collected. Tell how they are different from each other. Describe their colours, try to read the numbers, letters and words written on them. Can you tell the cost of the ticket? Can you guess on which bus it was bought? Compare the cost written on any two tickets and try to guess which of them was used for a longer journey.*

Students may be able to read numerals in English or the local language as they are printed on the ticket. You may write these numerals on the blackboard to help them. The tickets might also be colour-coded according to their cost. Students with tickets bearing the same cost may raise their hands and tell the colour of their tickets.

Some complications may arise here. The cost comparison may not work for distance if one of the tickets is for a child and another for an adult. Also the activity may get difficult if the cost of the tickets is written in decimal notation or is broken up into main charge plus tax. Please do adjust the level of demand of the activity according to the experience as well as literacy and numeracy level of your students.

Students' Drawings

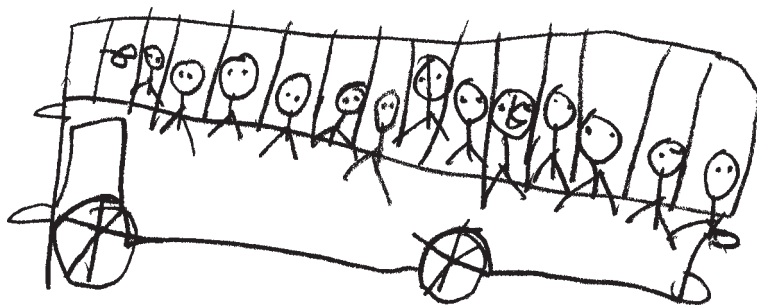

conductor thank you
for giving the
tickets

15. TRAINS AND TRAIN STATIONS

Trains are perhaps a unique example of a highly sophisticated technology forming part of a child's life-world. With their enigmatic sounds, rapid speeds and the far distances they go, trains truly fire the imagination of a child. And beyond this first attraction, trains and railway stations

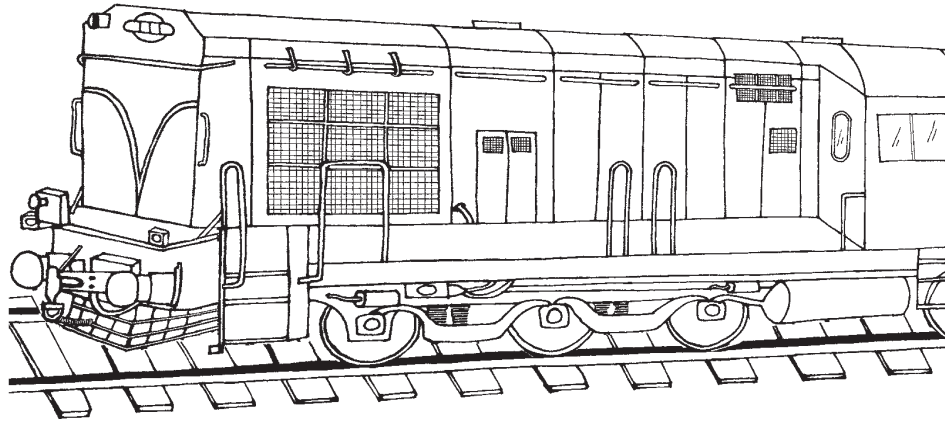

offer a host of opportunities to develop literacy and numeracy in meaningful contexts.

It is possible that you find great enthusiasm for trains only from the boys in the class. In that case please make special efforts to ensure active participation of the girls!

This is a topic in which you may find several unfamiliar words like "bogie", "signal" and even "pantograph". These words should be used if they occur naturally in familiar contexts - see Language Development on page 5. Take another example: "engine" is a familiar word which is used here, yet the correct word is "locomotive", i.e. the whole contraction of which the "engine" is one part. Though "locomotive" is a long word, children who have been on frequent train journeys would have been exposed to it (or its short form "loco") printed on various signs, and they would be thrilled to be able to read and recognise it.

Have you seen a train? Have you been to a railway station? Have you travelled by train?

Activity 15.1: Train! Train!

The teacher and students link hands or hold the person ahead, to mimic a locomotive followed by several compartments joined in a chain. Students who are familiar with trains might think of acting as a goods or passenger train, as trolley cars, as petrol or milk tankers, first and second class coaches, general and women's coaches, pantry car (from where food is distributed), luggage car, mail car, and so on. These different cars might be suggested with the use of simple props. Train stations could also be included in the action. An appropriate poem or song and various train sounds will go well with this activity. The songs and poems might be in the students' mother tongues rather than in English. Students may also know some train-related songs from popular films and may like to enact these scenes too.

Imitate the sounds made by trains.

With more experience students might be able to distinguish between a variety of sounds - sounds made by fast-moving wheels, the rattling of carriages, sounds of different train horns and whistles, sounds made by steam, diesel or electric engines and by generator cars. They might even have observed the increase in loudness of sound while a train crosses a bridge, goes through a tunnel, etc.

Have you been in a train that went over a bridge? Or through a tunnel? Describe how it felt and sounded.

What smells have you noticed around trains?

Smells may range from those of oil and burning coal or diesel, to disinfectants, to the inviting smell of food from the pantry car and from food vendors. You may have to help students put their observations into words.

Have you counted the "bogies" of a train? When you get a chance notice where and how two bogies are joined together.

"Bogies" are the wheeled carriages which carry the coaches and the engine or locomotive too.

Have you ever seen a train pulled by two or more engines? Have you seen an engine pushing a train?

Watch a train carefully from the outside.

In observing a train closely, students would notice fascinating details, like engines of different types, pantographs bobbing up and down on the roof of an electric train, the peculiarly shaped rims of train wheels which guide them along the rails, various kinds of springs, the pistons going in and out of drums, hissing of air brakes, water tanks being re-filled with long hoses ... and so on. Discussion in the class will encourage students to observe further. Please judge from students' interest and prior experience how many such words and ideas it is appropriate to introduce to them.

Can a train run on a road? What kind of "road" does it run on?

Activity 15.2: *Draw a picture of the railway tracks.*

Tracks are made of parallel steel rails connected by sleepers forming H shapes. Students might have noticed that the sleepers are made from wood, metal or cement.

Have you seen trains moving from one track to another? Show in your picture a place where a train might cross to another track.

Having tried to draw this picture, students will in future be more observant in watching train tracks and may even notice the switches which allow trains to move from one track to another.

! Take Care

Do not cross railway tracks, except at a pedestrian crossing.

Activity 15.3: *Make a model train using matchboxes, shoe boxes or other materials. Run the train along tracks drawn on the floor. Draw the tracks in such a way that your train can turn left or right without falling off the tracks!*

Where do you go to take a train? Have you seen a small or a big train station?

Known examples of train stations are necessary. Words like platform, foot over-bridge, subway, signal, stalls ... might be introduced here. Students could describe all that happens on train stations and on platforms. A major point of interest might be the food stalls and vendors.

To which town or city did you go to by train? Have you ever travelled by train inside a big city?

Give an example of a nearby "town" or a "city" and what it means to be "inside" a city. If possible

introduce ideas of local and long-distance trains, shuttles, etc..

Students would enjoy describing the train journeys that they have taken, which station they got on and off, the stations on the way, what they saw or did on the route, did they go up hills and over rivers, how long was the journey, any memorable events, etc.. Children often have lasting memories of food that they eat on journeys!

Take Care

Be careful while getting into a train. Don't try to get in or step out while the train is moving.

While on the platform, keep away from the edge especially when a train is passing by.

Cars and buses are parked in a "garage". Where are trains and locomotives parked? Have you ever seen a "yard" or a "shed"?

Activity 15.4: Draw pictures of a train or a railway station. Count the bogies in your train.

Depending on the students' experiences and interest you might go on to discuss trains for goods and for people, slow and fast trains, express trains, mail trains and passenger trains, as also different types of engines, the engine driver, motor man, guard, porter, station master, ticket window, ticket checker, platform ticket, etc.

How do you know when a train is coming to a platform and where it will go?

Students should know that trains are supposed to arrive and leave at specified times. They should have at least a rough idea about systems like platform and coach numbers, different signs, electronic indicator boards, printed time-tables, public announcements and so on, so that they pay attention to them and eventually learn to use them (they need not know all the words mentioned here). Although the practical use of these systems is more relevant for older people, for students they are useful in developing a general awareness as well as the skills of literacy and numeracy.

Activity 15.5: Make a collection of train tickets, passes and coupons.

Students should try to read the words and numbers written on the tickets, particularly the date of travel, the destination and the cost of the ticket.

Activity 15.6: Act out any scene at a train station. You might use the tickets you have collected to act out a scene at the ticket window.

New words

railway, tracks, rails, sleepers, locomotive, bogie, coach, compartment, local, outstation, yard, platform, indicator, announcement ...

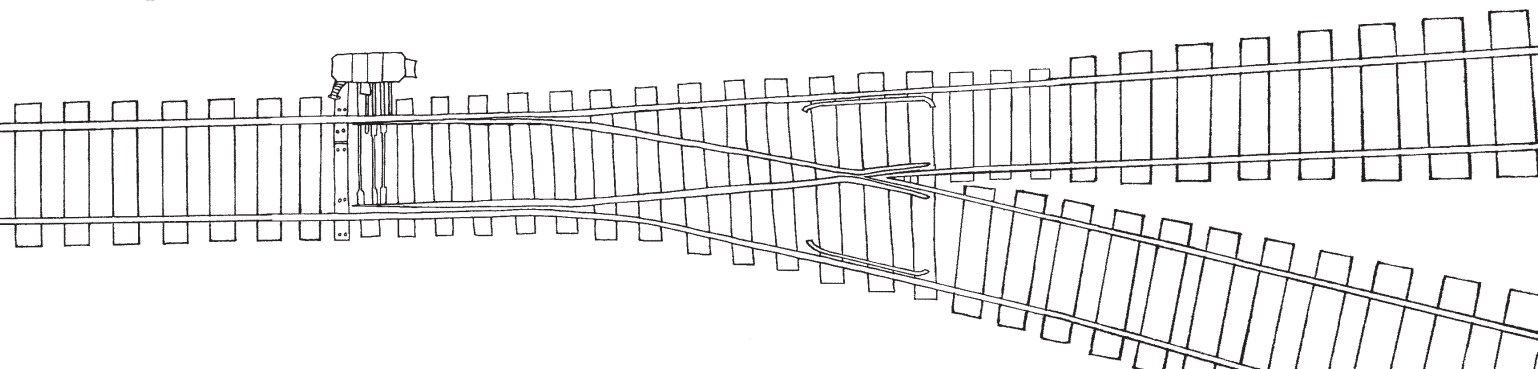

16. PEOPLE AT WORK



This topic aims to make students aware of the occupations of various adults around them, their work and their contribution to the community. Depending on their environment students may be exposed to a variety of different occupations. In earlier topics we have referred to school-related professions like the teacher, principal, etc.; bus conductor and driver, railway staff, vendors in the market, postman and staff in the post office, etc.

One professional with whom children come into close contact, and often remain in awe of, is the doctor. Students might relate their experiences and observations at the clinic, primary health centre or hospital - about the people there (doctor, nurse, staff, patients ...) and about common instruments like the thermometer, tongue depressor, stethoscope and injection syringe. As always, it is fine to use big words as long as they make sense in the child's world-view. Students might also act out a scene at the clinic, read simple printed words on medical prescriptions, try to feel their friend's pulse ... and so on.

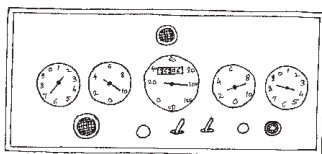

Apart from the ones mentioned so far, students may know of other professions, for example, scientist, engineer, architect, pilot, artist, actor, singer, dancer, musician, writer, poet, as also common occupations like the fisherman or woman, potter, farmer, shepherd, cobbler, artisan,

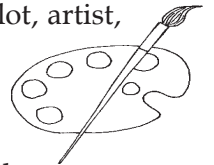
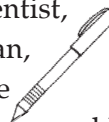

goldsmith, ironsmith, weaver, tailor, barber, waiter, milkman or woman, person, sweeper, rag-picker, farm labourer. They may know

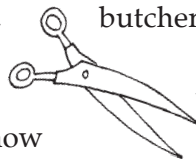

butcher, carpenter, mechanic, cook, gardener, newspaper delivery watchman, construction labourer, about prominent persons in

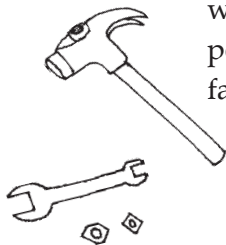

the community like, the village sarpanch, government official, soldier, priest, politician, policeman or woman, businessman or woman ... etc. In addition, in the locality there may be nomadic people or migrant workers engaged in



different occupations. And finally, do not forget one occupation that often remains unrecognised, that of a house-manager or house-parent!

This is a long list of occupations; in actual fact there may be only a few such occupations that are suitable for doing with your class.

Please do include occupations from all categories, to encourage respect for all types of work.

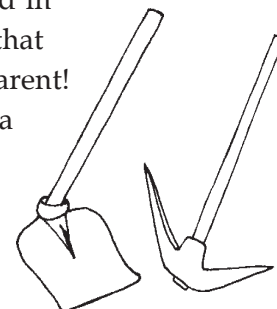

Students would learn a great deal by talking with a professional about his or her work. You might invite this person to the school, or if possible, take the students to their place of work. Make sure that the talking is accompanied by observation and demonstrations. A number of activities and projects could be built around a single occupation. Only some sample questions are given here. The possibilities are unlimited.

Have you seen this person working? Where?

What does (s)he do? What things (tools or implements) does (s)he use for this work?

In what way does (s)he help us all? What would happen if (s)he does not do this work properly or regularly or goes for a long holiday? Could someone else do this work? Could we do it on our own?

Some occupations may be full-time, part-time or seasonal.

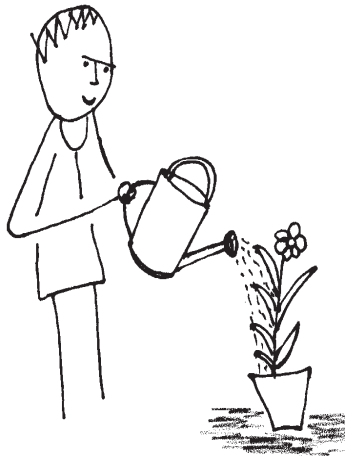

Activity 16.1: Watch these people at work. Talk to them and find out more about them and their work.

The class should meet some persons with different occupations. If you are visiting their place of work, instruct students to observe the work without causing disturbance and only later ask questions. Initially students may feel shy to talk with unknown persons and may need to be helped and encouraged.

Activity 16.2: Dumb charade - Recognise the person from a chit with a simple drawing (stick figure) and pictures of tools that the person uses. Act out this occupation for others to guess.

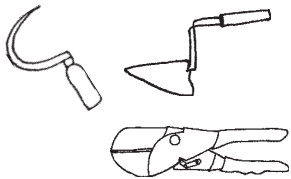

The initial guessing will be easy if the number of occupations is kept limited. It can be followed up with further acting - for example, students may perform different actions of a sweeper - say the use of a broom, dust-pan, mop and so on, while others guess the action.

Activity 16.3: Draw a person doing his or her work. Also draw the different things or tools which (s)he uses.

Activity 16.4: Make a "Thank-you card" for someone who you think is very helpful to all of us.



0

AUGUST							2004
Sun	Mon	Tue	Wed	Thu	Fri	Sat	
1	2	3	4	5	6	7	
8	9	10	11	12	13	14	
15	16	17	18	19	20	21	
22	23	24	25	26	27	28	
29	30	31					

UNIT 5

TIME

- 17. Day and night
- 18. Calendar
- 19. Festivals

17. DAY AND NIGHT

This topic deals with events happening over one day: a scale of time which is immediately meaningful in our "everyday" life. Other references to time over hours and days have come up in the topics of School and Market. The next topic will deal with events happening over months and years, while much shorter time scales of seconds will be introduced later, in *Small Science Class 3*.

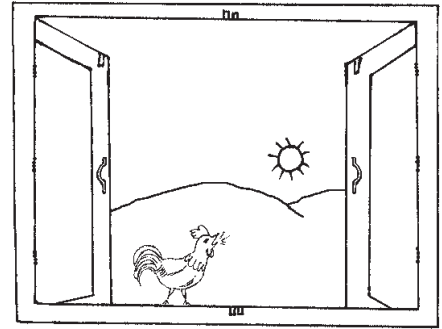

Wake up, clean up

Act out the things you do every morning on waking up.



Perhaps someone wakes you up - you open your eyes, sit up, stretch, get out of bed, look out of the window (is it bright outside or still dark), wash your face ...

Activity 17.1: *Bring to class at least one thing that you use to clean yourself in the mornings. Show or act out with the help of these things how you clean yourself.*

Students may bring tooth powder, a mug, soap, towel, comb, nail-cutter ... Some of these things may also be kept in the classroom for students who might have come to school without washing or combing their hair. In case your students need to be taught clean habits, this activity should be done on the first day of school.

Do you wash your hands and feet after playing outdoors? Do you wash your hands before eating anything?

Time of the day

*How can you tell when it is morning, evening or night?
What do you do at these different times?*

Activity 17.2: *Have you seen a clock? Pretend you are a clock!
What sounds does a clock make? What parts of it move?
Do the two (or three) hands move equally fast? Try to turn your arms as slowly as the hands of a clock. Now turn them faster!*

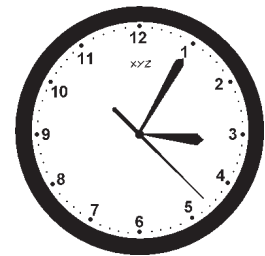

Bring a working clock to class. With the help of the students you might make a model cardboard clock with moveable arms, or find a ready-made toy clock or an old broken clock. Let students play with the clock and read the numbers on its face.

At what time do you usually wake up? At what time do you leave home for school? At what time does school begin? At what time do you reach home after school? What do you do at home after school? Do you go out to play? What games do you play? Act out all these things.

When do you eat your breakfast, lunch, dinner? At what time do you go to sleep at night?

Students may have only a rough idea about the times of the day. It is enough for them to be able to recall a long sequence of actions through the day, and to know some of the important timings.

What all do you do when you have half-day school? What do you do on school holidays?

Activity 17.3: *Divide a drawing sheet into four parts. Above each part write: "morning", "afternoon", "evening" or "night". In each of these parts, draw something that you see or do at that time of the day.*

Day and night

Have you seen the sun rise or set? Describe where you have seen it. How does the sun look just after sunrise or just before sunset?

Activity 17.4: *Watch the sky during the day. What different things do you see in the sky in day time? Watch the sky at night. What different things do you see?*

Sun, moon, stars, as also clouds, birds, aeroplanes, kites...

Which of these things do you see every day (or night), which ones do you see only on some days or at some times?

What do we see in the sky only in the daytime? What can we see in the sky only during night time? Are there things that we might see in the sky both during the day and night? Have you ever seen the moon during the day?

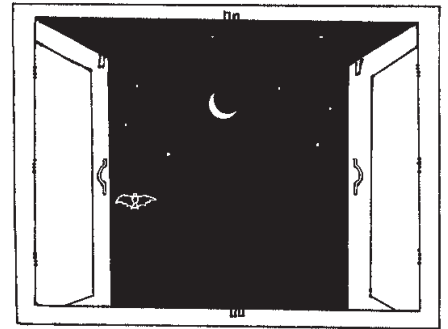

The next activity should be preceded by Activity 21.21 on page 104.

Activity 17.5: *Watch your shadow all through the day. Notice when it is long or short. Can you see a shadow when the sun is covered by clouds? Can you see a shadow at night? When is your shadow clear and sharp? When is it not so sharp?*

Do you see or hear some animals (including insects and birds) only in the daytime or only at night?

Activity 17.6: *Fold a drawing sheet into two parts. Write above the two parts: "Day" and "Night". Draw a scene of a day in the first part and a scene of night time in the second part. What things will you draw to show that it is day or night?*

Yesterday, today, tomorrow

Use these three terms in everyday conversation so that students become familiar with them.

18. CALENDAR

The time-scale of one year, though seemingly large, is nonetheless meaningful in a child's world. The months of the calendar fit in with the natural cycles of the stars, sun and moon, the cycle of seasons, of agricultural activities and festivals. More immediately for students, the calendar connects up with their school year, vacations and birthdays. It helps us think about past and future happenings and to perceive regularity in various natural, social and academic events over the year. In addition, the calendar is a powerful yet easily available tool which can support the development of literacy and numeracy.

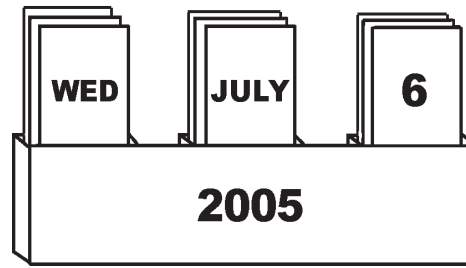

Here we are talking about the "Gregorian calendar" which is used throughout the world. In India this calendar is used for civic and administrative purposes while local calendars based partly on phases of the moon might be used for agricultural activities and festivals. Sometimes you will find these two types of calendars combined into one.

For this topic you will need a large calendar for the current year. Preferably it should have one month per page, done in clear, well-spaced lettering. If necessary you could make such a calendar. Ask students to look for any calendars in their own homes and possibly bring them to class. For some of the activities an old calendar will do too.

If students already have an idea of today's date and day of the week, you may begin by asking them that. The terms "yesterday", "today" and "tomorrow" should be known to all. Some familiarity with the names of the seven days of the week and the twelve months of the year will be good preparation for the topic of calendar.

Year

What is the year shown on your calendar?

The number showing the year is written on every page of the calendar. Find out where it is written.

Sun	Mon	Tue	Wed	Thu	Fri	Sat
				1	2	3
4	5	6	7	8	9	10
11	12	13	14	15	16	17

Write the current year on the blackboard. This is probably larger than any number that the students have seen before. In fact it is likely that students do not know of the existence of four-digit numbers; certainly at this stage they would lack the concept of such large numbers. Yet, through some associations this number denoting the year will still make sense to them. For example, they may have seen the year written prominently in a poster or advertisement; they may know other such numbers, say the year of their birth, or they may have heard of the "New Year", when this number increases by one digit. Though students may not yet understand it as a number, they should be able to write the digits of the year and say the number aloud.

Month

Count how many pages there are in your calendar.

Many calendars have twelve pages, perhaps printed back-to-back on six sheets. After identifying the pages for each month, you may teach students to recite the names of the twelve months. In this way, with increasing familiarity, students should be able to guess-read the names from the calendar page - for example, by knowing the position in the page where the name of the month is written, and noticing the first letter of that word. Such "reading" by pattern-recognition is possible much before students learn to spell such long words.

What year and month are we in now?

Open to that page in the calendar.

How many of you have your birthday in this month?

What month came before this one? What month will come next? Find out from the calendar.

What month comes after September? What is the month before July? etc.

Students should frame more such questions and ask them to each other.

Date, day and week

Draw the calendar of the month on the blackboard (see Activity 18.5). Follow the numbers using a pointer.

What is today's date? What does each of these numbers in the date tell us?

Explain which part of the date indicates the day, month and year.

Show today's date in this calendar. What day of the week is it today?

Activity 18.1: *Is there anything special about today? Is it a festival day? Is it someone's birthday? Is it raining hard? Is your favourite tree flowering? Is any special event due to happen today? Draw a small picture near the date on the calendar to show this.*

Some suggestions on festivals are given in the next topic. You may remind students about upcoming events so that they are prepared to observe more. Suggestions on observing plants are given in Activity 5.19, page 34-35. Personal events could be recorded on their own calendar (Activity 18.5).

Read out all the numbers for the dates in this month. How many days are there in this month?

Some printed calendars may need to be read horizontally and some vertically.

Read out every alternate date number. Now read out every third number. Notice how the numbers are arranged in the calendar. How many numbers are there in one line (row or column)?

Activity 18.2: *Count the number of school days in this month.*

This activity should be started on the first day of the month. On every school day put one pebble or a seed in a box. When ten pebbles accumulate, replace them with a larger stone or a seed. Another way could be to make tally marks above the calendar for the month. Students may count their own days of attendance using these same methods.

At the end of the month compare the number of school days with the total number of days in this month. How many holidays did you have this month?

In what colour are the dates printed?

Usually in two colours, red for holidays.

Which dates are written in red? Why are they coloured differently? What are the holidays shown in this month?

Sundays and other holidays, festivals and days of national importance.

Name the days of the week. Repeat the names of the days of the week while counting them on your fingers. How many days are there in a week? How many days are there in two weeks?

The names of the days may be written in short form in the calendar, using only the first three letters ("Mon", "Tue" etc.).

Show yesterday's day and date in the calendar. Now show tomorrow's day and date. How many more days till Sunday?

What day comes after Wednesday? What is the day before Saturday? etc..

What day of the week is the 5th of (this month)? What is the date on the second Friday of this month? What was the date on last Thursday? etc.

Students should frame more such questions and ask them to each other.

How many Sundays are in this month? How many Mondays? etc..

Count the number of weeks in this month.

Four weeks and a few more days, except in February.

What is the day on the 1st of this month? On the 2nd?

If the first day of that month is a Tuesday, then ask for the date on the next Tuesday, and so on. Through such exercises students would become familiar with patterns of numbers like 1, 8, 15, 22, 29 which are the result of successive additions of the number 7.

What is the last date of this month? What is the day? What day, date and month will come after that?

If December, what is the next year?

Activity 18.3: Do all months have the same number of days?

Students might be taught the trick to find out how many days in a month by counting the months on their knuckles. The rhyme "30 days hath September ..." may also be taught.

Birthdays

When is your birthday? Whose birthday comes in this month? Find your birthday on the calendar.

Activity 18.4: Draw a tower made of squares, one square for each birthday of a classmate in that month. Make each square a different colour.

Blackboard work: Picture graph of birthdays for each month.

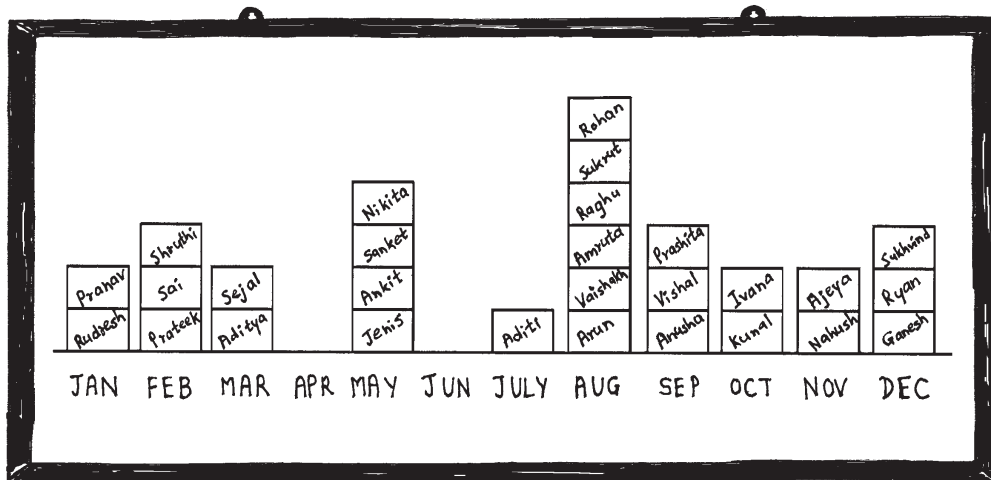

Similar graphs could be made by recording some other interesting or entertaining events through the months. For example, every day you may ask how many teeth fall out of the students in your class. Every month add up the number of teeth which fell out. At the end of the year students may make a graph for this data.

Ask your parents, on what day of the week were you born? Then check in the calendar, on what day of the week does your birthday fall this year?

How many months do you have to wait till your next birthday?

Your own calendar

Activity 18.5: Make your own Calendar.

Give to students an activity sheet for one month. Make a similar Table on the blackboard and use it for giving directions and spellings wherever needed. Do this activity three or four times during the year. Initially you may need to go step-by-step with the class, filling up the entire calendar on the blackboard as you go along. After some practice students will learn to do it on their own.

2004		JULY				
SUN	MON	TUE	WED	THU	FRI	SAT
×	×	×	×	1	2	3
4	5	6				

The following elaborate set of instructions for filling the calendar activity sheet might be needed in the first few months.

1. Which is the year going on now? Write it in the left blank space.

Point to the space in the sample sheet or on the blackboard.

2. Write the name of the month in the next blank space.

3. In the first row of the Table, write the names of the days of the week.

4. What will you write in the rest of the rows? Where will you write "1" for the first day of this month?

5. Put a cross in each of the empty blocks which come before the "1". Which was the day on 2, 3 ... (continue till the end of the week)? Now where will you write the next date?

6. Where will you stop? How many days are there in this month? What comes after the last day of the month?

7. What are the holidays in this month? Besides Sundays, do you have a holiday on any other day? For what reason?

Ask the students to keep their finger on that date while you check. If they cannot recall the dates then show them a ready calendar.

8. *How will you show the school holidays in your calendar? You could draw a circle or square around these dates. You may also draw an icon or symbol for that special day.*

Explain by drawing some common icons, for example the one for "danger" or "no smoking". Students may be familiar with such icons and may recall others too. Thus they will understand how a symbol is used to express an idea. Encourage them to come up with their own icons.

Students' Drawings

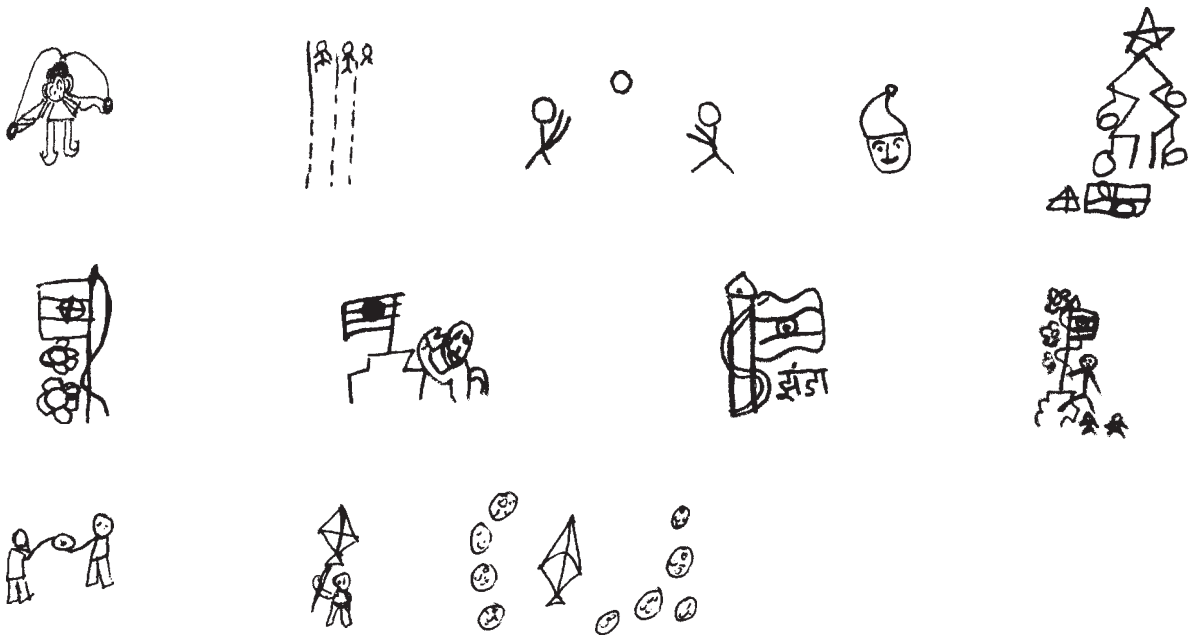

9. *Note any other interesting thing that happened or that you did on this day. You may mark on your calendar events like birthdays - yours or your friends' or family members', the school annual day or sports day, picnics, fairs, a visit from an aunt, a special feast at home, the days that you were unwell, and so on.*

10. *In your calendar draw and show the changes in your favourite plants in different seasons during the year. (See Activity 5.19 on page 34.)*

Help students choose a tree, preferably a deciduous one or one which blooms profusely. Ask them to notice it regularly for any changes. Do they see insects or birds near or on it? They may make a simple drawing of that tree every month or whenever they see any change.

19. FESTIVALS

With our diversity of religions, languages and ways of life, we Indians celebrate a large number of festivals all through the year. City dwellers tend to forget this, but most of our festivals derive from our traditional rural lifestyles, and some even go back into our tribal origins. Everyday aspects of village life are determined by the length of day, changes of seasons and the moon's phases. Such events and their connections with economic activities and family life are highlighted by our festivals, offering us a rich context for observational learning of the natural and the social world.

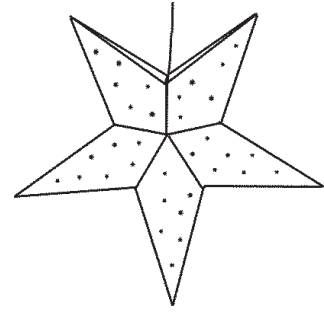

There are many examples of festivals which coincide with the turning points of seasons. *Diwali* is when the winter sets in. *Makar Sankranti* and *Lohri* mark the wane of the cold season in the North while *Pongal* and *Onam* signal the end of the winter monsoon in the South. *Basant Panchami* in North India welcomes the warmth of spring and the blooming mustard fields, soon after which *Holi* and *Baisakhi* mark the onset of summer bringing more new flowers. *Bihu* is celebrated in Assam three times in the year - as *Meha* or *Magh Bihu*, *Bohag* or *Rongali Bihu* and *Kati Bihu* - connected with the winter, spring and autumn seasons. *Ganesh Chaturthi* in Western India and *Dussehra* mark the end of the monsoon while at the same time in the East, *Durga Pooja* rejoices the end of floods and epidemics.

For the agrarian economy, seasonal changes bring major events like sowing, flowering of the crop and harvesting. The seasonal foods, decorations and characteristic festivities are closely bound with these agricultural events - *Makar Sankranti* is given later as an example. Traditional occupations like fishing and trading too have their own festivals and ways of celebrating them. Tribal festivals tend to be unique and specific to a tribe, though often they may be closely related with festivals more commonly known by other names.

Feasts of prophets and saints are important occasions for celebration and remembrance. Relationships like sister-brother, teacher-student, wife-husband and niece-uncle, come to the fore through specific rituals. All major religious festivals are celebrated in many regional variations. The appropriate classroom activities would therefore vary according to region.

Festivals, besides being social, economic and religious events, are the parts of our lives which connect up with astronomical happenings: the phases of the moon, the summer and winter solstices and the entry of the sun into specific constellations. Most of our festivals are

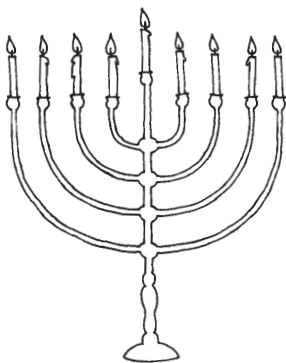

determined by lunar and luni-solar calendars. Students can begin to get an idea of these cosmic regularities by observing the shape of the moon on appropriate festival days. For example, notice the thin crescent moon of *Ramzan Id* and *Bhai dooj*; the near-full shape of *Dussehra*, *Mohurrum* and *Bakri-Id*, and the full moon of a number of different festivals like *Holi*, *Mahavir Jayanti*, *Buddha Poornima* and *Guru Parab* (see *Small Science Class 4 Teacher's Book* pages 74-75). *Hanukkah*, the Jewish festival of light, spans eight days around the new moon closest to the winter solstice.

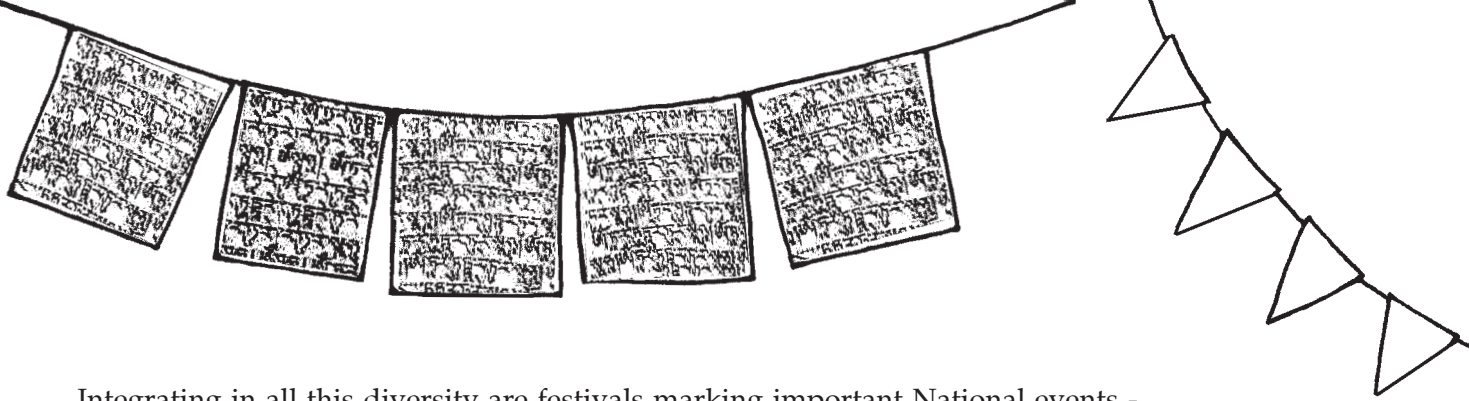

Integrating in all this diversity are festivals marking important National events - Independence Day and Republic Day. These are wonderful opportunities to help students gradually internalise the idea that we are all part of one large country, India.

General questions on festivals

Before the festival: *What is this day called? How do you greet each other on this day?*

Activity 19.1: *Story time!*

A teacher or a student might narrate a story related with a festival.

Activity 19.2: *Act out some scenes from the story.*

Activity 19.3: *Find poems and songs related with the festival.*

Activity 19.4: *Make a greeting card for an approaching festival. You might draw or paste in this card pictures of things used to celebrate the festival.*

Where possible, guide students to make observations of nature, linking these to ways of celebrating the festival. Some examples are given in the description of the festivals below. Look for more examples in your local environment.

Activity 19.5: *Make an exhibit related to the festival.*

You may depict some characters, scenes or celebrations associated with the festival. The classroom or a corner could be decorated as appropriate for that festival.

Activity 19.6: *Celebrate this festival in your school or class.*

The celebration may be arranged earlier or later, in case the festival day is a school holiday. Students may wear the appropriate kind of dresses and share a special food item related with the festival.

After the festival: *How did you celebrate this festival? Did you do anything special on this day? Did you and others wear new clothes?*

Did you have anything special to eat? Was any special dish made at home? Did you see how it was made? Did you help in making it?

Did you go out with your family? Where? Did friends and relatives visit you?

What do you like (or dislike) about this festival?

Activity 19.7: *Make a drawing to show how you celebrated the festival.*

Lohri/Makar Sankranti/Pongal/Magh Bihu

Makar Sankranti is an ancient festival. Some tribes of India celebrate this day as their new year. It is the day when the sun moves into the *Makar rashi* or approximately the Capricornis constellation. *Makar sankranti* has been given special significance because some 1400 years ago, the sun used to be in this same position during the winter solstice (i.e. December 22, the shortest day of the year in the earth's northern hemisphere). At present, the Sun enters *Makar rashi* in the third week of January, instead of on December 22.

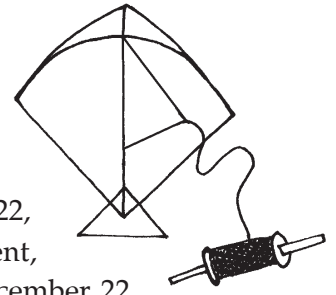

Makar Sankranti coincides with the *rabbi* harvest which happens towards the end of winter. It is the first major festival in January and one of the few festivals which closely follow the Gregorian calendar, falling on January 13, 14 or 15 every year.

In Punjab the day prior to *Makar Sankranti* is celebrated as *Lohri* by distributing sugarcane juice, new jaggery and sweets made from sesame seeds (*til*), followed by bonfire, *bhangra* and feasting in the evening. Sesame and jaggery are energy-rich foods appropriate for winter; besides, this is the harvest season for sesame and sugarcane. The Sindhis celebrate it as *Uttarayan* or *Dutran* - after bathing in water mixed with sesame, eatables including fresh fruits, vegetables and *til laddus* are given in charity. In Uttar Pradesh, this period is celebrated as *Kicheri* and in Madhya Pradesh as *Sukarat*. In Bihar special sweets are made from tender turmeric. In Maharashtra "*tilgul*" made of sesame seeds (*til*) and jaggery (*gul*) is exchanged saying "*Tilgul ghya, gode gode bola*" (accept this *tilgul* and speak sweet words). The day before *Sankranti* is celebrated as *Bhogi* when *bhakri* (*roti*) of *bajra* is eaten with mixed winter vegetables and tender roasted jowar (another *rabbi* millet) is had with seasonal fruits. The cool weather, clear skies and mild breeze are ideal for flying kites. In Gujarat there are community kite-flying competitions and the sky is filled with kites of different shapes, colours and sizes.

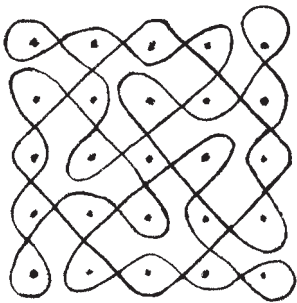

In Karnataka, Andhra Pradesh and Tamil Nadu, *Sankranti* is celebrated as *Pongal*, the harvest festival for paddy, sugarcane and turmeric. The *Makar Sankranti* festival at *Sabarimala* temple in Kerala is celebrated together by people of all communities. Celebrations in Tamil Nadu last for three days. On the first day, *Bhogi*, the house is cleaned and all old, unwanted things are burnt in the night while boys beat little drums called *Bhogi Kottu*. This is the day for worship of the Rain God. The next day, *Pongal*, is when the Sun God is worshipped with an offering of *Sarkkarai Pongal*, that is, rice boiled with milk and jaggery. Beautiful *Kolam* designs decorate the entrances to the houses. On the third day, *Maattu Pongal* or *Kaanum Pongal*, cattle are bathed, dressed with flowers, bells and colours, and honored for their hard work in the fields. Women pray for the health of their brothers.

Activity 19.8: Share a snack of *pongol* or *tilgul* or *revdi* or ... in class.

Activity 19.9: A long term activity - observe where and when the sun rises and sets.

About once every month observe when and where the sun rises (or sets) with respect to some landmark, say a tree or a house. Show this position in a picture. Note if there is any change in the time or position.

Vasant Panchami

Vasant or Basant Panchami falls on the fifth day of the lunar month of Magh. It is a spring festival celebrating the new leaves and flowers of spring. Mustard fields bloom



with yellow flowers. Trees like Mango and Cassia also begin to bloom. The festival is celebrated in Northern India and in Pakistan by Hindus and Muslims alike by wearing yellow clothes, eating yellow foods and participating in community activities like processions to *dargahs*, musical *mehfils* and kite-flying. In Bengal, *Saraswati pooja* is the main feature of the festivities.

In Southern India where winters are not too cold, spring is a less prominent season. Yet the warmth in the air and the flowering of trees is easily noticed. Spring is also the mating season for many birds. The sounds of bulbuls and magpie robins and the loud call of the *koel* are heard.

Activity 19.10: Learn to make kites and fly them.

Activity 19.11: Make the sound of the koel or another bird that you have heard.

Activity 19.12: Notice the shape of the moon a few days before and on the day of Basant Panchami.

Which other festivals have you heard of which are celebrated on a Panchami?

Panchami is the fifth day after the new moon. Other such festivals are, *Rang Panchami*, *Naag Panchami* and *Rishi Panchami*.

Activity 19.13: Watch the dark part of the moon.

Do you notice anything beyond the lighted crescent of the moon? Is the crescent moon actually still as round as ever? Make a guess.

Does the moon appear to be round like a plate or like a ball?

Holi

Holi falls on the full-moon day of the lunar month of *Falgun*. In North India, the winter (*rabbi*) crops of wheat, barley, gram, peas and turmeric are ready for harvest before *Holi*. Peepal and banyan trees don a fresh look with their new pink leaves. Other trees like the copper-pod, erythrina (Indian coral tree), *palash* or flame of the forest, silk cotton tree, ashoka, mango and neem begin to bloom around this time. *Holi* is the festival of colours!

Activity 19.14: Watch for a tree which has suddenly got new leaves or bloomed with flowers. The fallen leaves and twigs are burnt in a bonfire on the night before *Holi*.

Blackboard work: Name some colours. Now name one flower of each of these colours.

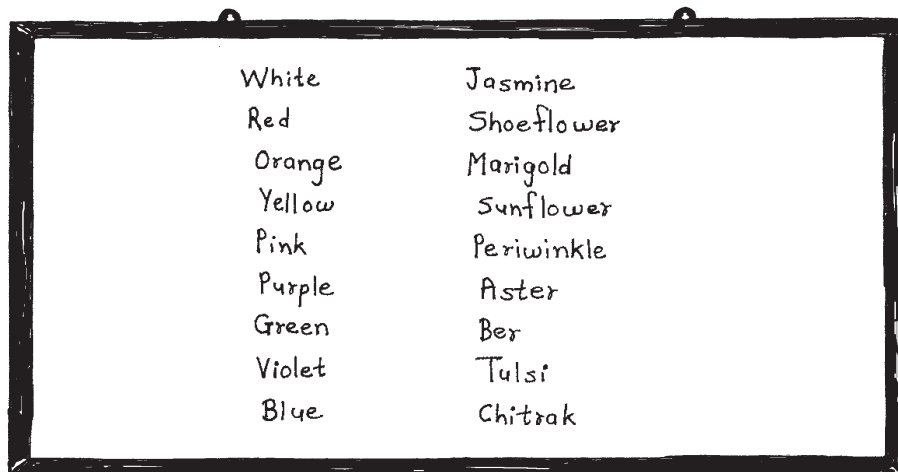

Activity 19.15: *Chip-chap*

Make a "chip-chap" with names of four colours written on the top and names of flowers of those colours written inside. Play a guessing game with this.

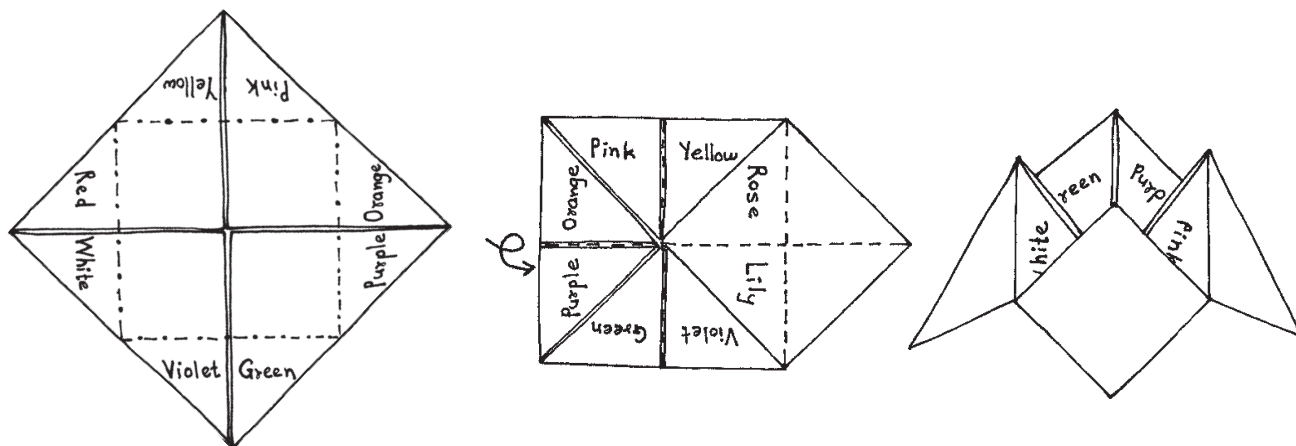

Use natural vegetable colours to play *Holi*! Do not use synthetic and colour-fast paints which are often harmful to the skin and eyes. Use only clean water. Do not throw water-balloons, they may hurt someone.

Traditionally *gulal* is made from the flowers of palash, also called *dhak* or *tesu* (*Butea frondosa* or *Butea monosperma*). Gulmohar is also used for red, shoeflower for purple while for yellow the flowers of Indian laburnum or *amaltas* (*Cassia fistula*), marigold or *genda* (*Tagetes erecta*), yellow chrysanthemum and black babul (*Acacia arabica*) are used. The flowers are dried in the sun, powdered and used directly or mixed in cereal or gram flour for bulk.

Be careful, do not use un-tried vegetable matter for *Holi*! Use only flowers or leaves which are edible or known, through long usage, to be safe. You might use beetroot for dark pink, a paste of spinach or tender leaves of the wheat plant for green, or *haldi* for yellow. For more ideas look at <http://www.cleanindia.org/btonature/holi.htm>.

Activity 19.16: Get different kinds of *pichkaris* to class. Fill them with water. Play with them as appropriate.

Activity 19.17: Share some *malpua*, *thandai*, *puranpoli*, *gujjia*, *papri* or whichever are the local snacks of the day.

Activity 19.18: *Holi on paper!*

Some flowers can be used to paint by rubbing their petals on to paper. Paint a *Holi* scene using flowers.

See Activity 5.12 on page 32.

Make a colourful face mask with flower-painting!

Activity 19.19: Find out and sing some *Holi* songs.

Activity 19.20: Watch for the moon on *Holi* night and then early next morning. Was the moon up in the sky all night?

Vishu, Navroze, Naba Barsha, etc.

The new year of many Hindu and some Buddhist calendars is celebrated on a new moon day around March or April, in the season of spring, close to the vernal equinox (first day of the lunar month of *Chaitra*). In Maharashtra and Goa this day is called *Gudhi Padwa*, in Andhra and Karnataka it is *Yugadi* or *Ugadi*, in Kashmir *Navreh*, while for the Sindhis it is *Chetichand*. *Poila Baishakh* or *Naba Barsha* in Bengal is the first day of the month of *Baisakh*. *Vishu* in Kerala and in Tamilnadu occurs on April 13, 14 or 15 as does *Rongali Bihu* or *Bohag Bihu* in Assam and *Baisakhi* in Punjab. It was on *Baisakhi* day in 1699 near Anandpur Sahib that Guru Gobind Singh founded the Khalsa Panth.

The Parsi new year, *Navroze*, is celebrated every year on the vernal equinox that is, March 21, when the time between sunrise and sunset is exactly 12 hours. The Jains celebrate new year on *Diwali* day, a tradition since adopted by the business communities in North and Western India. The Muslim new year, a more solemn occasion, is the first day of the month of *Mohurrum* which may occur during different times of the solar year.

Activity 19.21: Make a *gudhi* and hang it up in the class.

A *gudhi* in Maharashtra and Goa is a pole on top of which an upturned brass pot is placed and adorned with colourful silk cloth, marigold flowers and mango or neem leaves. You could find appropriate activities carried out on a local new year's day.



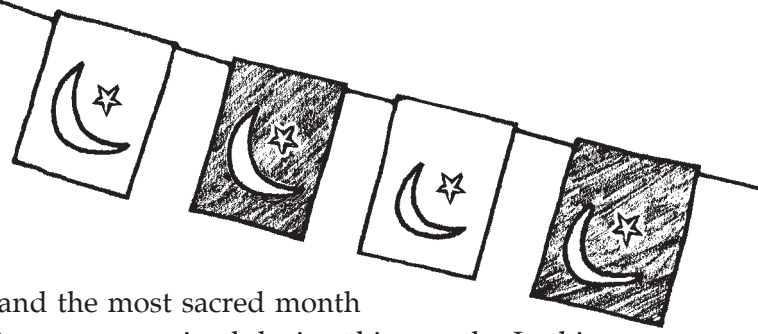

Ramzan Id

Ramzan is the ninth month of Muslim calendar and the most sacred month for Muslims of all sects. It is believed that the *Quran* was received during this month. In this month Muslims fast from sunrise to sunset, not even drinking water. The meal before sunrise is called the *Sehri* and after the sunset the fast is broken with *Iftari*. Prayer or *Namaaz* is offered five times in a day.

At the end of the month the *Ramzan Id* (or *Ramadan*, also called *Id-ul-Fitr*) is celebrated with special prayers, feasts, sweets and gift-giving. The aroma of *Shirkurma* (a sweet pudding or *kheer*) and *Biryani* is all over. People wear dazzling new clothes, wishing each other "*Id Mubarak!*" Children are happy with all the festivities, and the *Idee* (special pocket money) that they get.

Activity 19.22: Find out the ingredients of one special dish that is made during Ramzan Id.

Activity 19.23: Look at the moon on the eve of the Id. Draw and colour the (crescent) moon and the sky .

Activity 19.24: "*Chand ka kurta*" - a poem or story about the moon asking his mother to make him a kurta (shirt), but she complains that he changes size and shape every day!

Diwali

Diwali is celebrated on a new moon day after the autumn equinox. It is the last day of the lunar month of *Kartik*.



Activity 19.25: Draw a *kolam* or *rangoli* design on paper.

Give a worksheet with an array of dots, or nested square shapes or two concentric circles, inside which the students could make their own designs. They may also make their own small grid of 4 X 4 dots for drawing rangoli. A square-lined page would be helpful.

Activity 26. Make a *kolam* or *rangoli* design on the floor.

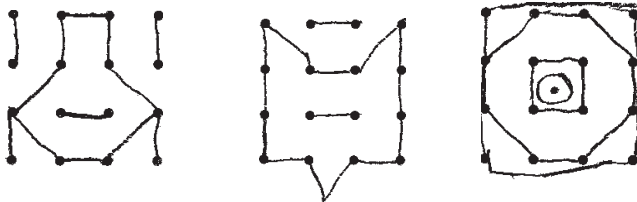

Student's Drawings

Groups of students could make a small *rangoli* design and fill it with colours or flowers. If floor space is not available, make the designs on pieces of cardboard or on old notebook covers.

Find out, what is kolam paste or powder made from? What is rangoli made from?

Activity 19.27: With your teacher's help prepare and light an earthen lamp.

Find out what the lamp is made from, how the wick is prepared and what fuels are used in the lamp.

Activity 19.28: Make a paper lantern.

Activity 19.29: Look for the moon on Diwali day. Observe its shape on Bhai-dooj day.

For how many days did you have holidays for Diwali? Show it on your calendar.

There are many problems with the often excessive and inappropriate use of fire-crackers during *Diwali*. Firstly, students should feel concerned about the exploitation of children like themselves who are forced to spend long hours manufacturing fire-crackers. Point out also the harmful effect of smoke and sound, particularly on old and sick persons and babies. Demonstrate the safe and limited use of fire-crackers, cautioning students against prevalent dangerous practices.

Christmas

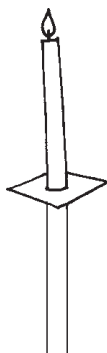

Christmas is celebrated every year on 25th of December as the day that Jesus Christ was born. On the eve of Christmas special prayers are offered at the midnight mass and Christmas carols are sung. Houses and churches are decorated. On Christmas day, people dressed in their best meet friends and relatives and have delicious food cooked in the style of that region. The fir tree (often a model of it, since fir does not grow in most parts of India) or an appropriate tree of the region is decorated and toy stockings are hung on it by children for Santa Claus to put gifts in them.

Activity 19.30: A teacher or older student comes dressed as Santa Claus.

Activity 19.31: Decorate a Christmas tree.

Activity 19.32: Loop and link colourful paper strips to make a long chain for decoration.

Activity 19.33: Make a Santa Claus mask.

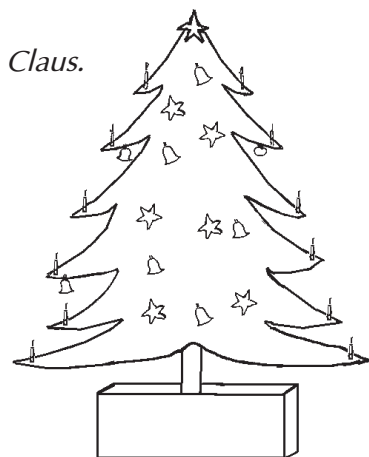

National festivals

Independence Day

After a long and difficult struggle, on August 15, 1947, India became free from 200 years of British rule. The best way to tell students about our independence struggle is through stories. There are a number of good books to help you, for example, Sheila Dhar's "*Our India*". Other books are listed on page 115 - 116.

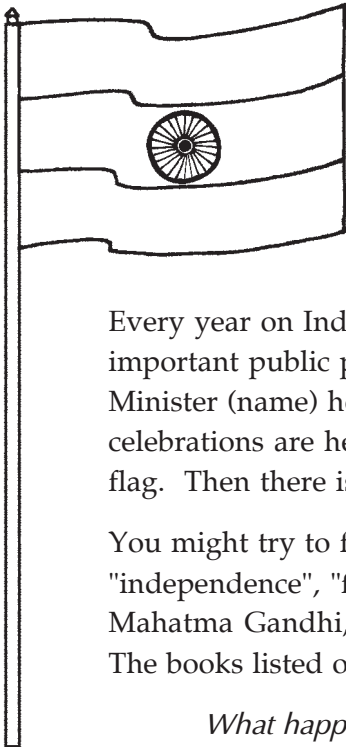

Republic Day

On January 26, 1950 the constitution of India came into force, that is, our leaders decided on the rules for how to run the newly-independent country.

Every year on Independence Day and Republic Day the national flag is hoisted at all important public places, including in our school. On Independence day the Prime-Minister (name) hoists the Indian flag on the Red Fort in Delhi. The Republic Day celebrations are held at Rajpath in New Delhi where the President (name) hoists the flag. Then there is the Republic Day parade ...

You might try to familiarise students with the difficult ideas of "country", "independence", "freedom", "flag" etc. with the help of pictures and stories about Mahatma Gandhi, Babasaheb Ambedkar, Sardar Patel, Maulana Azad, and so on. The books listed on page 115 will help.

What happened in our school on Republic Day? Who hoisted the flag? How?

Hoisting and saluting the flag; colours of the flag, the tri-colour or *tiranga* of saffron, green and white with the *Ashoka Chakra* having 24 spokes in dark blue. The flag is made of handspun and handwoven *khadi* cloth, sometimes also of handmade silk or wool.

Activity 19.34: Draw and colour our national flag.

The ratio of length to width is 3:2. You may draw it as 9 cm x 6 cm with the help of a ruler.

Activity 19.35: Learn to sing our National Anthem.

The lyrics and music of our National Anthem were composed by Rabindranath Tagore. Teach the correct tune and tempo - with singing or playing time approximately 52 seconds.

Activity 19.36: Learn some songs about our country.

Teach some simple patriotic songs.

Activity 19.37: Learn to recognise the National emblem.

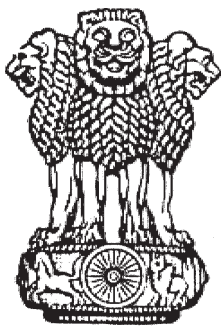

सत्यमेव जयते

Look for the National emblem of India on coins, bank notes, revenue stamps and government buildings and documents. The emblem is adapted from the top portion of the Ashoka pillar at Sarnath in Uttar Pradesh. The pillar, carved out of sandstone, stands at the place where 2500 years ago Gautam Buddha preached his first sermon. The pillar has four lion-heads facing four directions, below whom are four smaller animals, a lion, an elephant, a horse and a bull, alternating with four *Ashoka Chakras*. The emblem shows three of the lions (the fourth is hidden from view). Of the smaller animals the horse and the bull are visible in the emblem, with an *Ashoka Chakra* between them. Below the emblem is the motto "*Satyameva Jayate*", meaning, in Sanskrit, "Truth Alone Triumphs".

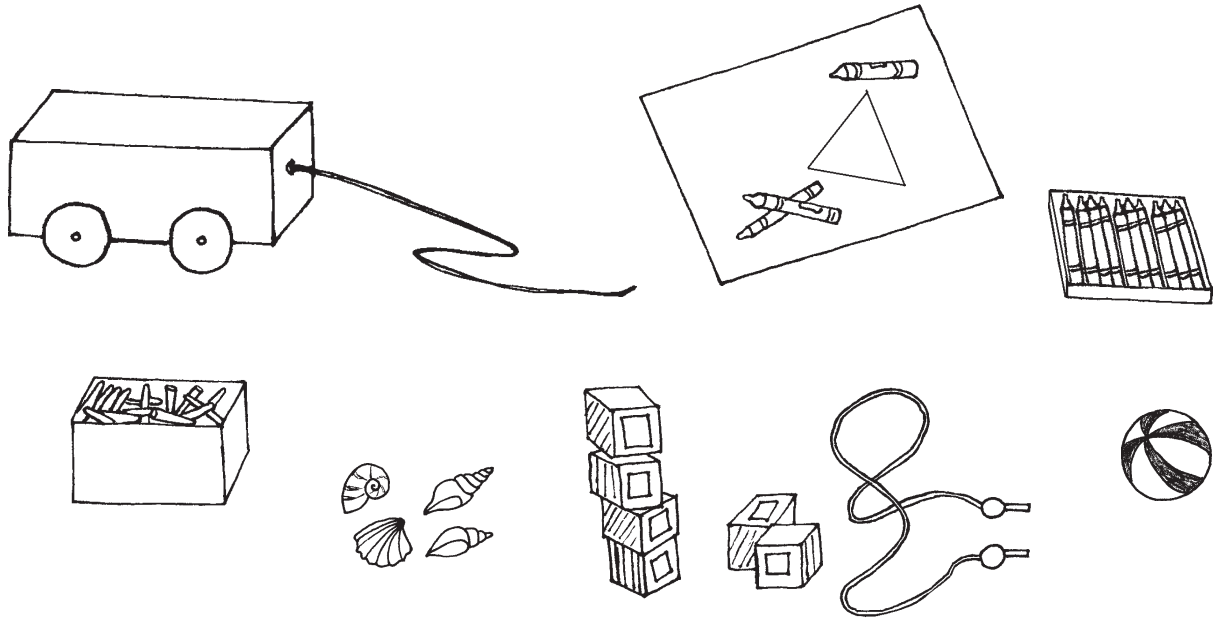

UNIT 6

THINGS AROUND US

20. Our classroom
21. Shapes and sizes
22. Going on a ride

20. OUR CLASSROOM

Though "Things around us" is the final Unit in this book, the first topic in it "Our classroom" might be introduced early in the school year. This topic will help develop students' vocabulary, enabling them to speak with clarity in relation to objects around them. Simple ideas about materials and properties as well as some number and space concepts are also introduced here.

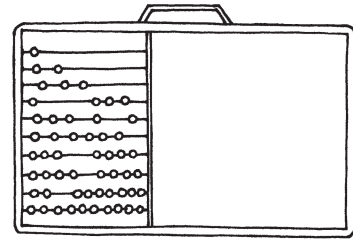

Things in the classroom



Name all that you see in the classroom.

Every classroom has its unique location and arrangement. Students should learn to name the objects in it including furniture and fittings.

Activity 20.1: Place this label near the object.

Prepare cards with names of different things in the classroom, preferably those with simple, easy-to-read names. In a large classroom where placing labels near objects may not be practicable, students might read the word from the blackboard and then point to the object.

Activity 20.2: Count these things.

Begin with objects in the classroom that are exactly one in number. Then go on to two, three, etc. Ask the students to count the objects and tell you, say, how many doors, windows, desks, bags, etc. are there. Conversely you may ask them to name the objects which are one in number, two, three, and so on.

Activity 20.3: What is this made of?

Consider different things in your classroom like books, pencils, pens, erasers, rulers, duster, handkerchief, coins, belts, purse, slippers, mirror, etc. which are made of some common materials like, wood, paper, cloth, metal, glass, plastic, rubber, clay, leather and so on. Preferably choose things that are made of predominantly one material. You may also add things from your collection of scrap objects, like old newspapers, bottles, bottle-tops, boxes, twigs and wooden articles, old keys, pieces of clay pots, pieces of bricks or pottery, scraps of cloth, bags, pieces of metal, etc.

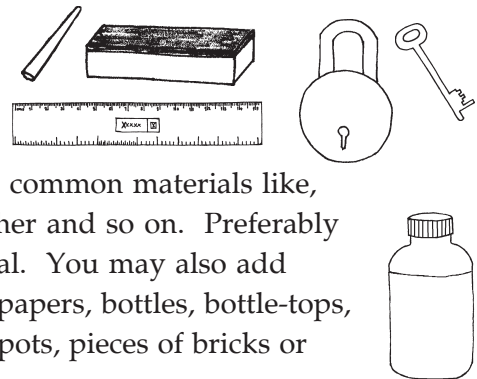

Activity 20.4: Group together all the things that are made of wood. Similarly group things made of paper, cloth, metal, glass, plastic, rubber, clay, leather ...

Point out other things in the classroom that are made of these materials.

Name other articles (outside the classroom) made of these materials.

You or the students might also think of other ways to group things, like colour, shape, texture, brittleness (things that break easily), things that are heavy or light, etc.

Activity 20.5: Spot the difference!

Hold up two similar objects, say two books, and ask students to come up with as many differences as possible. They may also express points of similarity. You may give a few pointers as below.

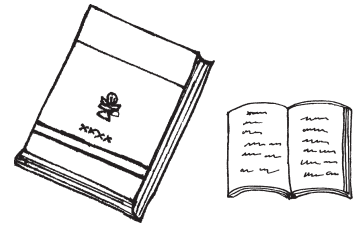

Notice the colours and pictures on the covers. Which book is larger, smaller, taller, shorter, wider or narrower? Which book has more pages? Which is thicker or thinner?

Have you read these books? What is written in them? Do they have any stories or pictures?

You might ask students in turn to hold up a book of their choice and say at least one sentence to compare it with a book of your choice.

Count the people

Activity 20.6: *Count how many people there are in the classroom. Do not forget yourself and your teacher!*

If this task is difficult, as it would be in a large classroom, ask each student to call out the numbers 1, 2, 3 ... serially. The last number called out, makes the total count.

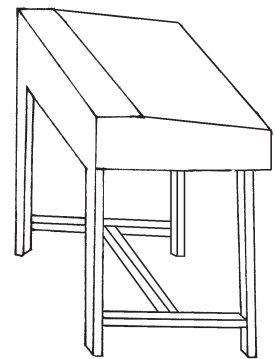

Activity 20.7: *Where are you in this classroom?*

On a large sheet of paper make a grid of blocks or circles according to the number of benches or the number of students in the class (the latter, in case they sit on the floor or in some other informal arrangement). Write the names of students in these blocks according to their seating arrangement. Place this sheet oriented similar to the classroom. Call the students one at a time to ask the questions below. During this time the other students might be engaged in another activity, say Activity 20.8.

Lightly shade with a crayon the block or circle in which your name is written. Who sits to your right? Find his or her name in the sheet. Point out in the class and then on the sheet, who is sitting to your left, in front of you and behind you.

If the students sit in rows, give each row a serial number. When you call out the number of a row, all the students in that row act out some pre-decided action, for example, stand up quickly and sit down again. You may make this activity more fun by calling out the row numbers randomly in quick succession.

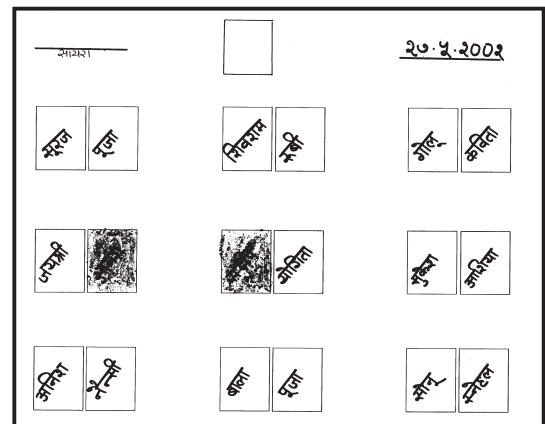

Sample worksheet in which students were asked to shade their name and that of the student on their right

Activity 20.8: *Make a drawing of your classroom or of some things that you see in your classroom.*

21. SHAPES AND SIZES



The aim of this section is to teach, through everyday observations, a few simple mathematical concepts. First we introduce some flat (two-dimensional) shape terms like, circle, triangle, square, rectangle and oval, encouraging students to notice such shapes in their environment. Depending on students' readiness, they may also be made aware of three-dimensional shapes like sphere (ball), cylinder, cone, cube, cuboid, pyramid and prism. Next we introduce sizes, lengths and weights. We end with some games on shadows.

Shapes

Activity 21.1: Group the similar shapes together. Learn the names of these shapes. Arrange the shapes into some patterns.

Use cut-outs of various shapes in different sizes from cardboard, old notebook covers, newspaper, or craft paper of different colours. Give each student or a group some of these cut-outs for sorting and making patterns. Introduce the terms circle, triangle, square, rectangle and oval.

Blackboard work: Which different shapes do you see in this picture?

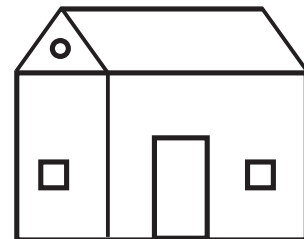
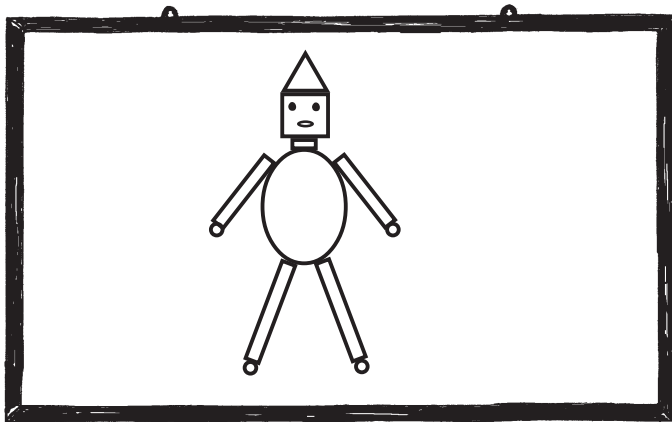

Blackboard work: Circles and Ovals: Fill the circles, hatch the ovals.

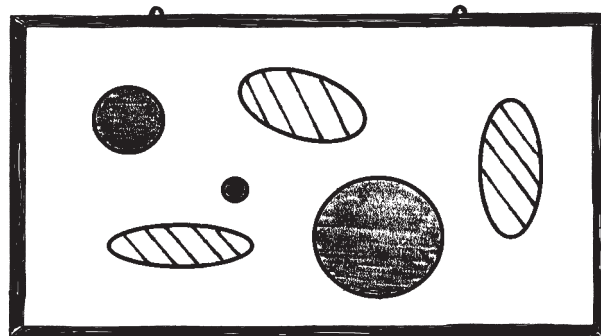

Blackboard work: Squares and Rectangles: Fill the squares, hatch the rectangles.

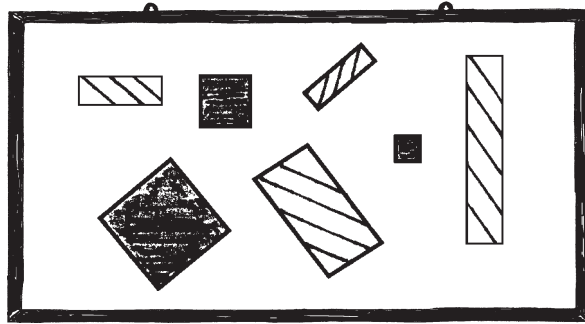

Worksheet: Several simple shapes are drawn in different sizes and orientations. Students colour each type of shape, say, all squares, in a particular colour. Next they draw and colour shapes of their own.

Name some objects shaped like these, in the classroom and outside.

Triangle - tiles, sandwich ...; Rectangle - book or page, blackboard, slate, top of a table, door or window-frame, bed, TV screen; Square - slice of bread, top of a stool, handkerchief ...; Circle - roti, bangle, ring, wheel ...

Activity 21.2: Draw different kinds of lines and curves.

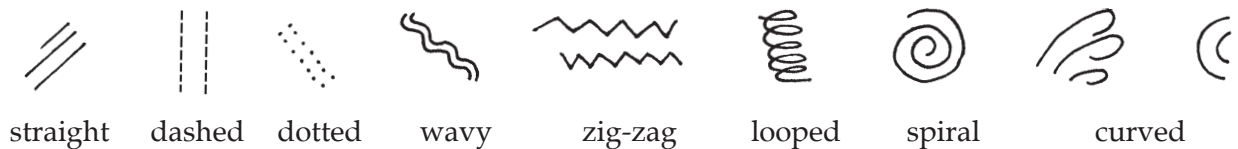

Now draw straight lines in different ways - standing, sleeping or slanting.

Activity 21.3: Draw different kinds of triangles.

Worksheet: Colour only the triangles among these.

Blackboard work: Which of these are triangles?

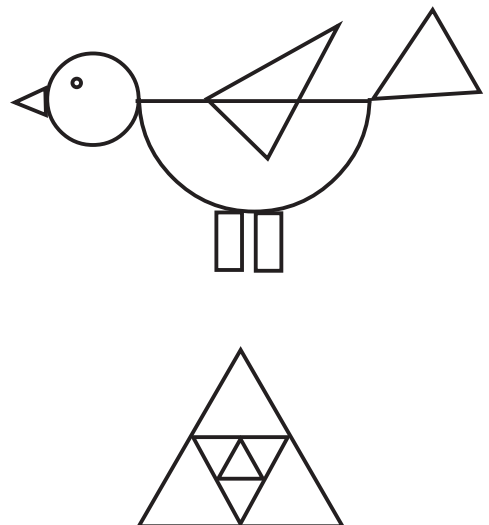
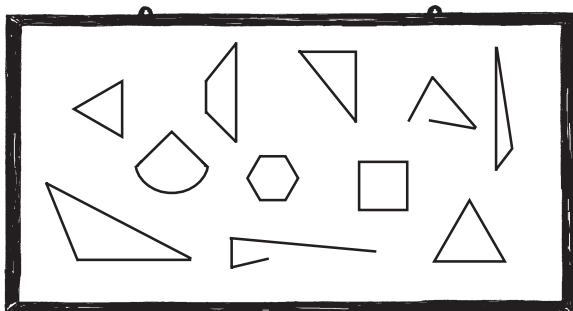

Activity 21.4: *Shapes from sticks*

Start with four matchsticks or toothpicks per student.

How many different shapes or designs can you make using all four sticks?

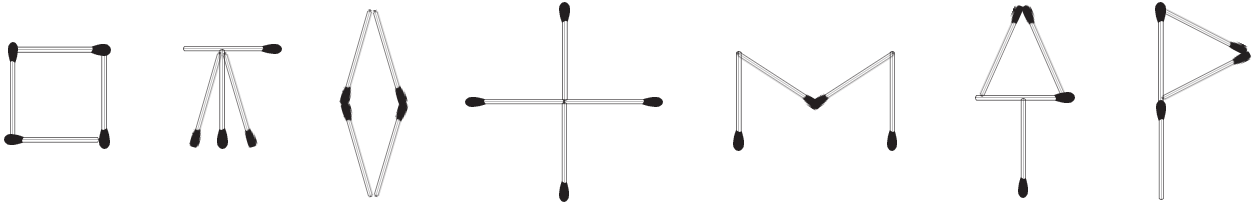

How many different designs can you make using five or six sticks? Once you make a design, copy it on a paper before trying a new one.

Students will realise that increasing the number of sticks just one at a time, results in the number of possible designs increasing remarkably quickly.

Activity 21.5: *Make different shapes using small sticks. Make a picture by pasting sticks on to a sheet of paper.*

Now make some alphabets in this way. Which alphabets can be made using only straight sticks and which ones cannot?

Use pieces of broom-stick, matchsticks or twigs. Sets of sticks of the same or different lengths might be given to students. By playing with these sticks and trying to make different shapes out of them, students will also get a feel for lengths. You may set them other tasks with the sticks, as suggested next.

Activity 21.6: *Which set of sticks will you choose for making an H shape?*



Which set will you choose for making a triangle?



Activity 21.7: *Draw a picture using different shapes.*



Blackboard work: *What will come next?*

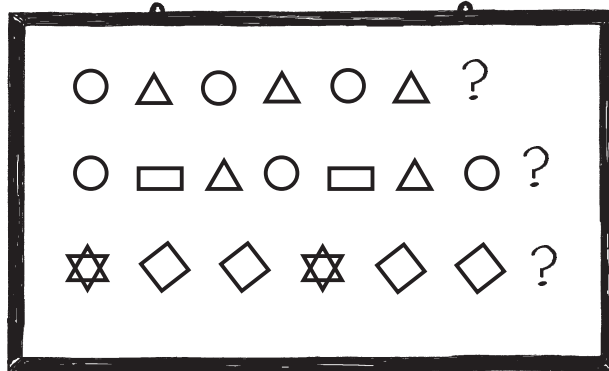

Draw some simple patterns on the board. Ask children to come and draw the next shape.

Now draw patterns similar to the ones drawn on the board but with different pictures.

Activity 21.8: *Recall the designs.*

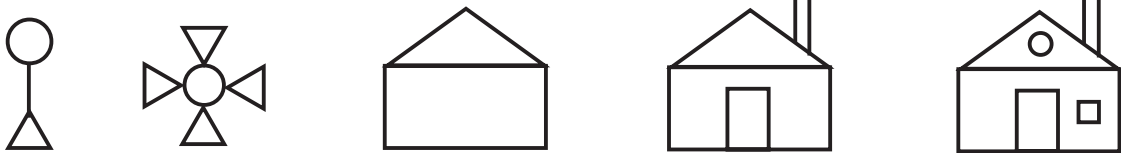

Draw on a large sheet of paper a simple combination or a design made up of the basic shapes. Show this to the students for a few seconds.

Remember this design and draw it later.

Show the design again after the students complete their drawing to let them compare the two. Repeat with other designs or make the same design a little more complex each time, asking students to spot what is added to the design and then to add the details to their own design.

Activity 21.9: *Tear or cut out different shapes from an old newspaper or magazine.*

Activity 21.10: *Turn one shape into another.*

Rectangular sheets of paper are given to the students.

What is the shape of this paper? Fold it into a square. Now unfold it into a rectangle.

Take another square. Fold to make a triangle from this square.

Try to make other triangles out of this triangle.

Can you make a circle from a square?

Activity 21.11: *Halve the shape.*

Make cut-out shapes from paper similar to those used in Activity 21.1, but these cutouts should be foldable. Use some bilaterally symmetric and some asymmetric shapes, as shown in the figure.

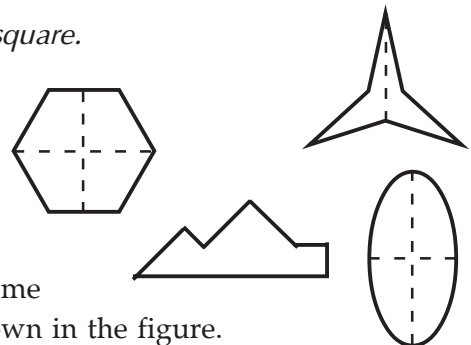

Fold the shapes to divide them into equal halves.

Can you fold all the shapes into equal halves? Before folding guess whether the shape will fold into equal halves and write 'Yes' or 'No' on the cut-out.

Is there more than one way to fold this shape into equal halves?

Guess whether these shapes can be folded into "quarters" (four equal parts)? Shade one of the quarters.

Two children want to equally share a paratha. Use circle cut-outs to show in how many ways they can do this.

Shapes which are not flat!

Name things shaped like a:

Ball (lemon, orange, pea, laddoo, bead, marble, ball-bearing, soap bubble)

Box (brick, duster, matchbox, dice, carton, cupboard)

Rod (pencil, pole, pillar, pipe, tin can, steel dabba, log of wood, tubelight)

Cone (funnel, chana pudu, birthday or joker cap, ice-cream cone)

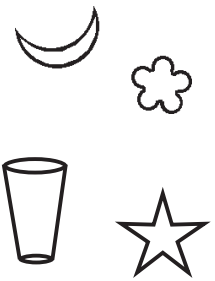

Draw a few interesting shapes, like the shape of a star, kite, flag, bottle, glass, the moon ...

Sizes

Activity 21.12: Smallest to biggest.

Before the class ask the students to collect ten pebbles or stones of different sizes.

Count the stones that you have brought. Pick up the smallest of all the stones and keep it aside. Then count the remaining stones. Again choose the smallest of the remaining stones and keep it behind the previous stone and count how many are left. Repeat with the remaining stones.

See, you have arranged the stones in order of size. Show me which way the size is "increasing" and which way it is "decreasing".

Activity 21.13: Tear a small piece from a sheet of an old newspaper. Crumple and roll it into a ball. Now make a ball bigger than the first one. Make a few more such balls of different sizes. Arrange these balls from largest to smallest.

Students will realise that a larger sheet of paper makes a larger ball - but all balls should be rolled equally tight. The balls may also be made from clay or dough.

Activity 21.14: *Shortest to longest.*

Take pencils or twigs or paper strips or ropes of different lengths and arrange them from the shortest to the longest.

Blackboard work: *Shortest to longest.*

Draw some horizontal lines of increasing or decreasing lengths on the blackboard.

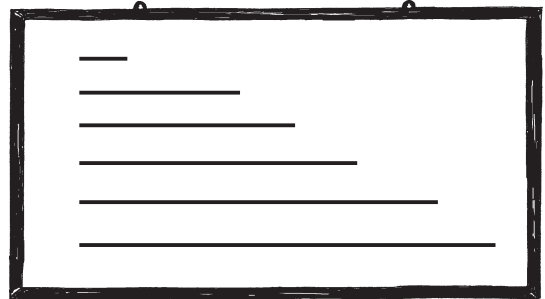

*Is the second line different from the first one?
What about the third line? What is the difference?*

Now, you draw such lines (from shortest to longest or vice versa).

Students may not at first realise that the starting points of the lines need to be vertically aligned.

Make patterns by drawing lines of different lengths.



Activity 21.15: *Who can jump the longest?*

Outside the classroom, draw a line on the ground. One-by-one jump from this line; try to jump as far from the line as you can. Mark where you reach by drawing a line there (parallel to the first line). Who could jump the longest?

Activity 21.16: *Shortest to tallest.*

Stand in small groups and arrange yourselves in a line, according to your height. Who is the tallest and shortest among you all? Who all are taller than you and shorter than you? Are any of you of equal height?

For the next two activities collect empty cardboard boxes of different sizes, for example, matchboxes, cartons of toothpaste, tea powder, shoes etc., or water-proof containers like bottles, glasses, tin cans, vessels, etc.

Activity 21.17: *Which is the biggest, smallest, tallest and shortest? Which shapes are broad, which are narrow?*

Activity 21.18: *How much does it hold?*

Give each small group of students some containers of different sizes and some water or sand.

Fill a container with water or sand, then pour the contents into another container. Does the other container fill completely? Does anything still remain in the first container?

Now pour from the second container into another container. Can you tell, before pouring, if all the contents will fit, or not, or if any room will be left over in the next container?

Activity 21.19: *Heavier and lighter*

Make some simple weighing balances (see *Small science Class 3*, page 56). Give a weighing balance to each of a group of students. Let them try to balance the instrument, putting different things into both pans to see what happens. This early playful introduction to the balance will prepare them well for the measuring activities and concepts to be done in later classes.

Activity 21.20: *Smaller and heavier?*

Make some sets of containers, for example:

1. A large empty bottle and a small empty bottle
2. A large bottle full of water and a small bottle full of water
3. A large empty bottle and a smaller bottle full of water
4. A bigger cardboard box full of leaves and a smaller one full of stones or sand.

For each set, ask one student to guess which is heavier and which is lighter. Another student could lift up the containers to tell if the guess is right.

Shadows

Activity 21.21: *Out in the sunshine, watch your own shadow. Is it of the same shape and size as you? Move in different ways and see how your shadow changes.*

Activity 21.22: *How do you cast the shadow? One of you cast a shadow on a sheet of paper using your hand. Another student trace around the shadow using a crayon. Exchange positions when you finish. Try to make different shadow figures and trace their outline.*

Activity 21.23: *Play this game with some friends. While the others run, one of you try to stamp on their shadow. When someone's shadow gets stamped, he or she has to stand still, till the end of the game. The student whose shadow gets stamped on last is the winner and will catch others in the next game.*

Activity 21.24: *Another little game with shadows: touch something and see if your shadow touches it too. Now move away your hand, but in a way that the shadow of your hand still touches it!*

22. GOING ON A RIDE

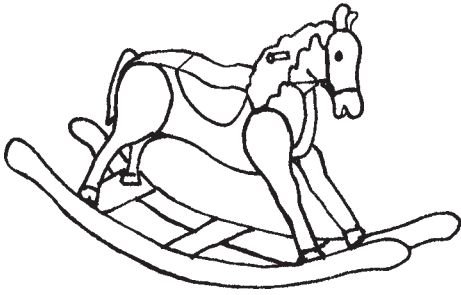

Moving vehicles can be a joy. Babies like watching vehicles pass by, and even better, riding on one. There is something fascinating about these contraptions which are not alive, yet move purposefully from one place to another. Older children play with toy vehicles, and enjoy taking a ride, whether on a simple push-cart or bicycle, or on a high-speed train. We have already (in Unit 4) talked about buses and trains. Here we take up other familiar vehicles, and also introduce some new ones.

Watch out for vehicles!

Activity 22.1: Bring to class any toy vehicle. In Topics 14 and 15 you may have made a model bus or a train. Keep these toy vehicles in the display area in your class.

Tell the class whether you have watched, or travelled in, some vehicle.

Imitate the sounds of different vehicles.

Blackboard work: Which vehicles do you know?

Vehicle	Moves on	Wheels
bullock-cart	rough road	2
bus	road	4, 6 or 8
car	road	4
cycle	road	2
rickshaw	road	3
train	tracks	many
boat	water	0

Bicycle, tricycle, scooter, motorcycle (motorbike), mo-ped, autorickshaw, phut-phut, bullock-cart, camel-cart, horse-cart, tractor, car, jeep, bus, van, truck, train, boat, ship, submarine, airplane, helicopter ...

Students may know, yet not readily name, some unfamiliar vehicles like ships or airplanes. Give pointers like,

How would you go across a river or an ocean, how do people go to a far-away country, ...?

Write some common vehicle names in a column on the left of the blackboard. In front of the respective names add the responses of students given in answer to questions asked during further discussion.

What (road, etc.) does this vehicle move on?

On rough land, on a road, on (or in) water, in air.

How many wheels does (this vehicle) have?

Group the vehicles in this way, or write the number of wheels next to the name of the vehicle. Preferably restrict this discussion to common and familiar vehicles.

Which do you think is the smallest, and which is the biggest of these vehicles?

The vehicles might be listed in an increasing order of size or given a serial number according to size.

Size comparisons might be made between two vehicles, or else between the vehicle and some familiar objects in the surroundings. You might also ask, "Could this vehicle pass through that gate?" or, "Could it fit inside this classroom?" Such an imaginary or fantastic situation, for example, "Could a truck fit into our classroom?" might be entertaining to some children, but it might as easily be confusing or frightening to some, so use your judgement about the kind of comparisons to suggest.

How many people, do you think, could fit into this vehicle? Does this vehicle also carry goods?

Why do we go from one place to another? Why do we need to travel?

Activity 22.2: *Ask a few people about their reasons for travelling. How often do they travel? Where do they go? On foot or in some vehicle? How much time does it take to reach there?*

If I have to go say, from the school gate to a nearby shop, how should I go? If I have to go a little further? Or very far? Could I walk up there or should I take a vehicle? Why?

Give suitable examples of places or landmarks in your area.

Would you reach a place quicker by walking or by riding on some vehicle?

Take Care

Always be careful on the roads. Use footpaths to walk along a road. Cross the road with an adult. Look both ways before crossing.

Which vehicle do you think goes the fastest? Which one would take the least time to reach some place? Which vehicle would you use to go to (give the name of any far-away place known to students).

Which vehicle goes the slowest?

Try to number or rank the vehicles according to their (maximum) speed.

Fuel for vehicles

Even the youngest students could get some idea about energy by relating it to the use of fuels.

After walking or running for a long time we get tired and say, "I don't have energy any more." We need energy to walk, or run, or do any work. We get energy by eating food. When we pedal we give energy which moves the bicycle. Where does the energy come from to move a bullock-cart?

How does a scooter or a car move? What gives it energy?

Students may know of fuels like petrol and diesel. Depending on students' experiences, this discussion might be extended to vehicles using other energy sources.

Take Care

Fuels can catch fire. Stay away from them. Keep them away from matchboxes, fire-crackers, lighters and open flames.

Choose any two familiar vehicles:

In what ways are these (two vehicles) different? In what ways are they similar?

Activity 22.3: *Draw some vehicles that you see or use often.*



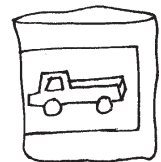
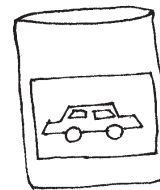

Activity 22.4: *Count the vehicles going by.*

Station a group of students at a safe place close to a road such that they can watch the vehicles going by. Give to the group some pebbles along with a set of paper bags each with a picture of a common vehicle. On a busy road it may be better to choose a time with less traffic than usual, whereas in a remote area a time of more traffic would be preferable.



Watch out for the type of vehicle whose name or picture is given to you. Whenever this type of vehicle passes by, drop a pebble in that bag. After say ten minutes count the number of pebbles in each bag to know how many such vehicles have passed by in that time.

Write the names of all the vehicles which were counted, or make small drawings of them, along a straight line. Line up the pebbles for that vehicle in front of its name or picture.

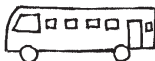
Cycle		○○○
Scooter		○○○○○○○
Rickshaw		○○○○
Car		○○
Bus		○○○

Or you may draw a bar made of little squares next to the name or picture of the vehicle. Draw as many little squares as the number of that kind of vehicle counted by your group.

Look at this picture-graph and tell - which kind of vehicle did you see the most? Which kind of vehicle went by the least number of times?

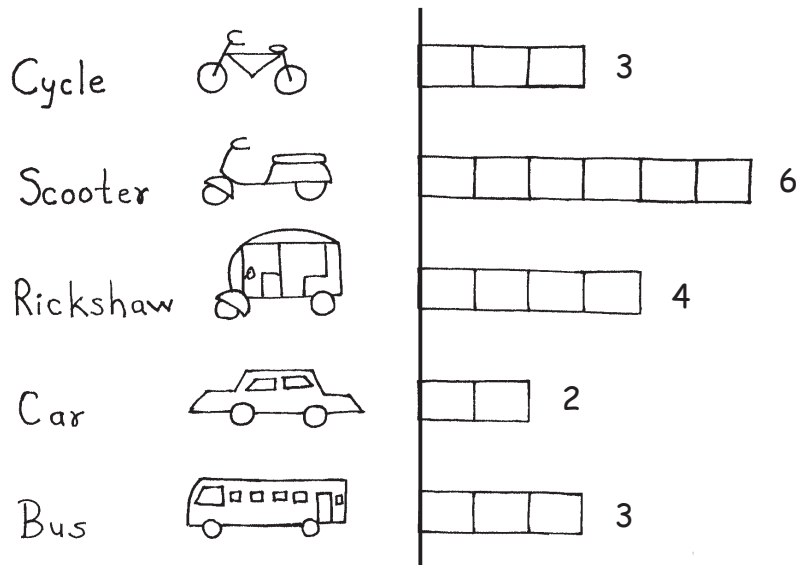

Finally, you may introduce some absolutely new vehicles like, ships, submarines, airplanes, and even space-ships. They would be fascinated to see photographs of people (astronauts) who have landed on the moon and close-up views of the planets.

Do you know that people have sent space-ships to the moon, and to planets such as Mars, Venus, Jupiter, Saturn and even beyond? Of these, the moon is the closest to us, and people have landed on the moon. So far, no person has gone beyond the moon but space-ships have carried cameras which have sent us back photographs of these far-away planets!

We leave the final topic of this *Teacher's Book Class 1 and 2* on this high note - children have a vast potential for learning. Listen to them, work with them and literally, the sky is the limit!

Students' Drawings

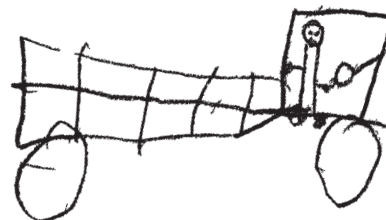
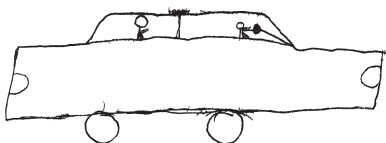

Games offer enjoyable routes to a host of learning opportunities. While contributing to physical and mental fitness, games foster muscular, visual-spatial and interpersonal skills. Outdoor and indoor games help fine-tune children's eye-hand coordination. Along with dance and gymnastics, games develop in the child an awareness of his or her own body and of its movement in space. Complementary to the formal academic program, games can develop verbal, logical and mathematical skills too. Many games encourage imagination and creativity, help children focus on a task, and develop their patience, discipline and understanding through following of rules and directions.



Children develop social skills naturally while interacting with their peers during games. They learn to co-operate, adjust to sometimes conflicting demands, and give their best in a team effort.

Thus play is a rewarding experience, essential to a child's all-round development. Some games relevant to the topics in this book have been suggested at appropriate points. Here we give a general list of some common games. A few of these you may find ridiculously common, but they are given here for your reference. You may adapt and modify them to your purpose. The games might be played in the physical activity period or offered as reward for good work or discipline.

Most of the games described here are appropriate for small groups of five to fifteen children. If these games are known in your area, please refer to them by their local names (some English, Hindi and Marathi names are mentioned here). Also add to this list other locally-played games.

Outdoor games

1. Run and chase or Tag (*Pakda-pakdi*)

The "den" runs around trying to catch one of the other children, who then in turn becomes the den.

There are interesting variations on this game

i) Team tag or Chain-chain (*Sakhli - sakhli*)

Whoever the den catches, links hands with the den and they together try to catch the others. This chain of catchers lengthens by one each time a child is "tagged".

ii) Statue tag or Ice and water (*Vish-amrut*)

The den catches one player saying, "Ice" or "*Vish*". Now this player freezes in his or her posture till touched by another player who says "Water" or "*Amrut*". Thus the den has to try to not only "freeze" all other players but also to not let them touch the ones who are already tagged.

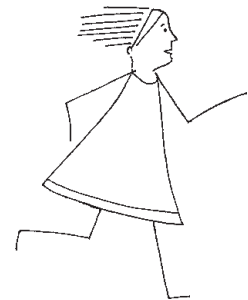

iii) Relay tag

One of the players carries something light, like a ball or a roll of paper, which is easy to carry while running. The den tries to catch this player, who must dodge the den and pass the object on to another player, whom the den must then try to catch.

iv) Hop and tag (*Langdi*)

The den hops on one leg to catch the others. Else the players divide into two teams. Players of one team run while one player of the other team hops and tries to catch them. If this player touches the lifted leg to the ground, then he or she is out of the game and the next player of that team enters the play. When all the players of one of the teams are out, the other team is declared the winner.

v) Cops and Robbers (*Chor-pulees*)

This game involves a run, chase and hide between two teams, the police and the thieves. In the next round the two teams exchange roles.

vi) Spot the colour or Pinky, Pinky!

The den is asked, in rhyme-form, "Which colour do you want?" The other players have to spot this chosen colour around them, say on someone's dress or on a plant or on anything else. They run and touch this colour before the den gets them!

2. Hide and Seek (*lukachhupi* or *Lapachhapi*)

A fixed place, such as a tree or a wall, is chosen as home base. Here the den, facing the base, closes his or her eyes and counts till ten, or in steps of 10 up to 100. The other players find a place to hide. On finishing the count, the den looks around and on spotting a player calls out his or her name, while touching the base. If the den goes on to locate all the players, the one who was spotted first becomes the den in the next round. But if any player comes out of hiding and, without the den noticing, touches the base or taps the den's back, then the play begins again with the same den. This game is enjoyable if there are lots of hiding spaces for the children.

3. Pillars (*Khamb-khamb*)

As many circles as the number of players minus one are drawn on the ground, 10-15 steps apart from each other. Players stand in these circles and try to exchange their places while the den tries to catch those who are out of the circles. If pillars or tree-trunks mark the spots then circles are not needed.

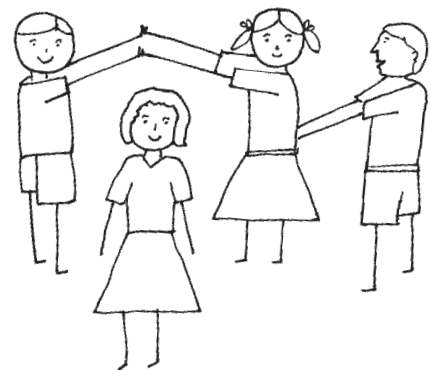

4. Hills or water? or Sea, sand, water, land (*Dongar ki pani*)

Children decide how to divide the play area into "mountains" or "sand" and "water". The den is asked to choose one of the areas (through a rhyme: In Hindi - *Arotha ya parotha, ghee ka ya tel ka, asli ya nakli, patthar ya pani, ya zameen ya asmaan ya ...* ; In Marathi - *Nili shaai kora kagad, aamhi kunala bheet nahi, kaccha doodh peet nahi, dongar ki pani*). The den tries to tag whoever comes into his area.

5. Find the egg (*Murgi, murgi, tera anda kahan hai?*)

This game needs a small object and lots of places to hide it. The "egg" is hidden without the den looking. The den is given some riddles or hints to find it. When the "egg" is found, the player who hid it becomes the next den.

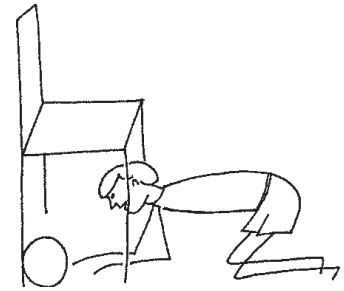

6. Jump over the hurdle (*Kanda-fodi*)

The den sits with one leg stretched out in front. The players jump one by one over this hurdle. The den increases the height of the hurdle by lifting one leg over the other, adding hands and then bending in different ways.

7. Fire in the mountain, run run run ...

The den chants this verse, while the rest of the players go around in a circle. Suddenly the den calls out a number. The players quickly form groups of this specified number. Players who remain out recite the verse the next time.

8. Statue.

The den repeats "Ring, ring, ring ..." while the children rotate around themselves spreading out their hands. Suddenly the den calls out "Statue!" and everyone must become still, striking an interesting pose. The den gives points to the players, but also tries to tease and make them laugh. Anyone who moves before getting the points is out.

9. Duck, duck, grey duck! (*Aaicha patra haravla*)

The children sit cross-legged in a circle and the den goes round them, calling out "Duck, duck, duck ...", each time tapping on a player's head. All of a sudden, tapping on a player's head the den says "Grey duck!" and runs. This player now has to run and try to catch the den before the den completes the circle and sits in the empty place.

Alternatively, the den carries around a handkerchief. Everyone sings together a small song or poem ("I sent a letter to my friend and on the way I dropped it. Someone came and picked it up and put it in his pocket"). At the end of this, the den drops the cloth behind one of the players, who has to notice it and chase the den.

More outdoor games

More outdoor games - Dodge ball (*Aabadhubi*), *Lagori*, Jump the rope or Skipping (there are so many ways to do it!), Hopscotch, Tug o' war (oranges and lemons) ...

Indoor games

1. Guess who tagged you (*Tikli maarun ja*)

The children together choose a nickname for each child (say names of fruits, flowers, animals, birds etc.), without letting the den know. Now one child closes the eyes of the den and calls any of the children, using the nickname. Whoever is called comes forward quickly (if a child forgets his nickname he or she is out!), gently taps on the forehead of the den and goes back. The den has to guess who tagged him.

2. *Chidiya udi* or *Chimni udali*

The children sit in a circle with the tips of their forefingers poised on the floor. One of them calls out names of different things quickly one after the other. The players lift their fingers only for names of things that can fly (for example, birds like sparrow, crow and insects like housefly as also light-weight objects like paper, feather, etc.).

3. *Apdi - tupdi* or *Aapdi - thapdi*

A group of five-six children sit in a circle and place their palms in the front, facing the ground. One of them goes around the circle tapping the palms and sings (in Hindi - *Apdi-tupdi peepal ka paan, nana ne pakda nani ka kaan!*) At the end of the song, the child whose palm is tapped last holds his or her neighbours ears. This is repeated till everyone is holding each others' ears with both the hands. Then all the children exclaim "Cheow meow, cheow meow ..." and tickle each other!

4. Memory game

A set of a few small things (with simple names) are kept covered with cloth. The cloth is removed for a minute or two and children are allowed to see the objects. Then the objects are covered and children write down (or list orally) the things they remember. Some more object(s) may be added or removed and the children asked to recall what is added or missing.

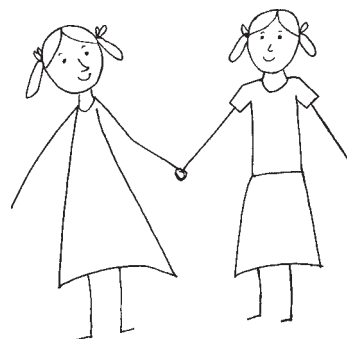

5. Passing the parcel

Any light object, "the parcel", is passed around among the group while one child, facing away from the group, makes some sort of sound (like clapping, tapping ...). The sound is stopped abruptly. Whoever holds the parcel at that moment has to perform a task given by the group, for example sing a song or rhyme, act out, etc.

6. Group stories

One child starts telling a story and after a minute halts at an exciting moment. The next person picks up the story from here and the same thing continues, till someone ends the story.

7. Tongue twisters

One by one children come forward and repeat a tongue twister as fast as they can, while the others count. The one who repeats the most times without making a mistake wins. (The phrase may be written on the blackboard.)

Some simple tongue twisters in English - Toy boat; She sells sea shells (on the sea shore); Red leather yellow leather; Six thick sticks ...

In Hindi - *Katccha papad pakka papad; Oont ooncha oont ki peeth oonchi oonchi oont ki poonchh.*

8. Riddles

Simple riddles like, "I have teeth but no mouth. What am I?", "You cry when you cut me. Guess what I am." are fascinating to children. You can make up such riddles and also ask children to make up their own.

9. Sixteen chits (*Sola chitthi*)

Four chits each of four different things (or as many as the players) are made by drawing and writing on small pieces of paper. These are then folded so that the contents are not seen. All the chits are mixed up and each child picks up any four of them. The aim is to collect all four chits of the same type. For this, each player serially puts down one unwanted chit and if the next player needs this chit he will pick it or pass it to the next player. This continues till one player wins by getting all four chits of one type. The winner quickly places his or her palm in the middle and the rest join in, placing their palms over one another for second, third ... positions.

Some more indoor games

Five stones (*Sagar-gote*), Snakes and ladders, Ludo or *Challas*, Chor police (with chits), Tic-tac-toe, Dots and dashes, "Ring around the rosey", Guess the tune, Word-finding, Jigsaw puzzles ...

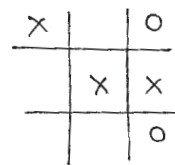

Crafts

Craft activities too improve fine-motor skills and provide space for creative expression. Activities like threading beads, weaving mats out of rope or strips of paper, paper-folding or origami, cutting or tearing out patterns in paper, clay work, fort-making with mud, collage work (filling up an outline with bits of old or waste coloured paper or cloth), making simple masks out of paper bags, preparing match-box models, pattern making from imprints (say, using crumpled paper, thread ball, or cut vegetables) ... would liven the class. Do not specify the procedures for any craft activity too rigidly. Leave enough room for individual expression.

FURTHER READING

Reference Books For Teachers

General

- Arvind Gupta: Ten Little Fingers: Ideas and Activities in Science, National Book Trust (NBT), New Delhi, 2001.
- Cathy Spagnoli: The World of Indian Stories, A Teaching Resource of Folk Tales from Every State, Tulika, Chennai, 2003.
- Eleanor Watts: The Blackboard Book, Sangam Books, Hyderabad, 1995.
- Harbin Robert: Origami - The Japanese Art of Paper Folding, Octopus Books, London, 1971.
- Holly Hebet: 50 Nifty Paper Crafts, Viva Books Pvt. Ltd, New Delhi, 1995.
- Krishna Kumar: The Child's Language and the Teacher, NBT, New Delhi, 1986.
- Mary Ann Dasgupta and Khitish Chatterjee: Low-cost/ No-cost Teaching Aids, NBT, New Delhi, 1997.
- S. Paramasivam and Cathy Spagnoli: Simple wonders: Toy Stories to Make and Tell, Tulika, Chennai, 2001.
- Sudarshan Khanna: Joy of Making Indian Toys, NBT, New Delhi, 1992.
- Tarabai Modak: 'Goshti Sangnaryansaathi Chaar Goshti' in Marathi (How to Tell Stories), Maharashtra Balshikshan Parishad, 2003.
- Author not mentioned: Read Aloud Stories, Children's Book Trust (CBT), New Delhi, 1980.

Unit 1

- Sarada Bulchand: Sense of Smell, NBT, New Delhi, 2002.

Unit 2

- Harinder Motihar: The Wonderful World of Insects, NBT, New Delhi, 1996.
- K. S. Sekharam: Our Useful Plants, NBT, New Delhi, 1982.
- Maneka Gandhi with Yasmin Singh: Brahma's Hair - The Mythology of Indian Plants, Rupa and Co., New Delhi, 1989.
- Pippa Mukherjee: Common Trees of India, Oxford University Press (for Worldwide Fund for Nature - India), Bombay, 1983.
- Radha Khambadkone: The Summer Tree Contest, NBT, New Delhi, 1982.
- Ruskin Bond: The World of Trees, NBT, New Delhi, 1975.
- Sharmila Kantha: Animal Fair, CBT, New Delhi, 2000.
- Sirish Rao: Leaf Life, TARA Publishing, Chennai, 1998.
- Zai and Rom Whitaker: The Snakes Around Us, NBT, New Delhi, 1988.

Unit 3

- Bishwajit Chowdhary: Vegetables, NBT, New Delhi, 1997.
- Ranjit Singh: Fruits, NBT, New Delhi, 1997.

Unit 4

- Gijubhai Badheka: Divasvapna, NBT, New Delhi, 1998.
- Mitra Phukan: Chumki Posts a Letter, CBT, New Delhi, 1994.
- Tetsuko Kuroyanagi: Toto-Chan. The Little Girl at the Window, Kodansha Intl., Tokyo, 1982.
- Vallikkanan: Madam Rides the Bus, NBT, New Delhi, 1982.

Unit 5

- A. K. Ghosh: Legends from Indian History, CBT, New Delhi, 1968.
- Krishna Chaitanya: How India Won Her Freedom, NBT, New Delhi, 1973.
- Premchand: Festival of Eid, NBT, New Delhi, 1989.
- Sheila Dhar: This India, Publications Unit, Ministry of Information and Broadcasting, Government of India, New Delhi, 1973.
- Uma Shankar Joshi: Stories from Bapu's Life, NBT, New Delhi, 1973.
- Various authors: Festivals of India, NBT, New Delhi, 1982.
- Authors not mentioned: Our Leaders Series (Books 1 to 10), CBT, New Delhi, 1989.

Children's Books

General

- Sigrun Srivastav: What's Right, What's Wrong, NBT, New Delhi, 1990.
- V. Suteyev: Me Too, Eklavya, Bhopal, 2002.
- Cathy Spagnoli: Priya's Day, Tulika, Chennai, 1998.

Unit 1

- Jeyenthi Manokaran: I Like the World, NBT, New Delhi, 1997.

Unit 2

- A. Ravishankar and Pulak Biswas: Tiger on a Tree, TARA Publishing, Chennai, 1997.
- Alaka Shankar: Time to Rhyme, CBT, New Delhi, 1980.
- Ashish Sengupta: Set Me Free, NBT, New Delhi, 1995.
- Ashok Davar: The Flower and the Bee, NBT, New Delhi, 1973.
- Aurobindo Kundu: Animal World, NBT, New Delhi, 1986.
- Debasish Deb: The Story of a Mango, NBT, New Delhi, 1993.
- Hydrose Aaluwa: Tails, NBT, New Delhi, 1992.
- Indu Rana: A Baby Lion Learns to Roar, NBT, New Delhi, 1999.
- Jagdish Joshi: A Voice in the Jungle, NBT, New Delhi, 1986.
- Jagdish Joshi: How Munia Found Gold, NBT, New Delhi, 1984.

- Jagdish Joshi: One Day ... , NBT, New Delhi, 1999.
- Judhajit Sengupta: A Crow's Tale, NBT, New Delhi, 1993.
- Kala Sashikumar: Eecha Poocha, Tulika, Chennai, 1996.
- Marti: What is a Tree, NBT, New Delhi, 1994.
- Niranjan Ghoshal: Name That Animal, NBT, New Delhi, 1990.
- Pranab and Smita Chakravarti: Our Tree, NBT, New Delhi, 1985.
- Pulak Biswas: Busy Ants, NBT, New Delhi, 1987.
- Rajesh Lavlekar: Pictorial - The Thirsty Crow, Jyotsna Prakashan, Mumbai, 2001.
- V. Suteyev: The Boat, Eklavya, Bhopal, 2000.
- V. Suteyev: The Mouse and the Pencil, Eklavya, Bhopal, 2000.
- Viky Arya: This is My Story, NBT, New Delhi, 1990.

Unit 3

- Akshata Balsekar: Little Learner's Library: Fruits, BPI (India) Pvt. Ltd., New Delhi, 2002.
- Akshata Balsekar: Little Learner's Library: Vegetables, BPI (India) Pvt. Ltd., New Delhi, 2002.

Unit 4

- Manjula Padmanabhan: A Visit to the City Market, NBT, New Delhi, 1986.
- Mrinal Mitra: My First Railway Journey, NBT, New Delhi, 1990.

Unit 5

- Akiko Hayashi: Hello Moon, NBT, New Delhi, 1986.
- Mehroo Wadia: We Indians, NBT, New Delhi, 1997.
- Ravi Paranjape: Diwali, NBT, New Delhi, 1985.
- Sandhya Rao: Look, the Moon!, Tulika, Chennai, 2004.
- Viky Arya: Discover India Through Mazes And Games, NBT, New Delhi, 1998.

Unit 6

- Akshata Balsekar: Little Learner's Library: Shapes, BPI (India) Pvt. Ltd., New Delhi, 2002.
- Gopal Nandurkar and Rahul Deshpande: Joy of Painting Vehicles, Jyotsna Prakashan, Mumbai, 1998.
- Trosky Marudu: Line and Circle, Tulika, Chennai, 1996.
- Uma Ahmed: Colour Craft 5: Colour and Shapes, Orient Longman, Mumbai, 1996.

OUTLINE OF THE HOMI BHABHA CURRICULUM

(Primary Science)

CLASS I and II

- Unit 1: Me and My Family
- Unit 2: Plants and Animals
- Unit 3: Our Food
- Unit 4: People and Places
- Unit 5: Time
- Unit 6: Things around us

CLASS III

- Unit 1: The Living World
 - Chapter 1. So many living things!
 - Chapter 2. Looking at plants
 - Chapter 3. Grow your own plant
 - Chapter 4. Looking at animals
- Unit 2: Our Body, Our Food
 - Chapter 5. Our Body
 - Chapter 6. Our Food
 - Chapter 7. Our Teeth
 - Chapter 8. Taking care of our body
- Unit 3: Measurement
 - Chapter 9. How many, how much?
 - Chapter 10. How long, how high, how far?
- Unit 4: Making Houses
 - Chapter 11. Houses of all kinds
 - Chapter 12. Make your own house

CLASS IV

- Unit 1: Sky and Weather
 - Chapter 1. Sun, wind, clouds and rain
 - Chapter 2. Day sky, night sky

Unit 2: Air

Chapter 3. Fun with air!

Chapter 4. What's in the air?

Unit 3: Water

Chapter 5. Fun with water!

Chapter 6. Water and life

Chapter 7. Water and us

Unit 4: Food

Chapter 8. Where our food comes from

Chapter 9. Food in our bodies

Chapter 10. What is thrown out

CLASS V

Unit 1: The Web of Life

Chapter 1. Living together

Chapter 2. Soil

Unit 2: Moving Things

Chapter 3. How things move

Chapter 4. Making a cart

Unit 3: Earth and its Neighbours

Chapter 5. Our earth

Chapter 6. Day and night

Chapter 7. Earth's neighbours

Unit 4: Our Bodies

Chapter 8. What is in our bodies

Chapter 9. Staying healthy

Unit 5: Materials

Chapter 10. The things we use

Note: The topics in Class I and II cover environmental studies. Classes III - V are primarily concerned with science, though keeping in view social and cultural perspectives. The topics begin with everyday experiences and immediate surroundings in Classes I - III, moving gradually outwards. Classes IV and V make increasing use of measurement concepts.



FEEDBACK FORM

(Small Science)

Date:

Name:

Profession:

School/ Institution:

I have read these books

I have tried these books with students

TextBook Workbook Teacher's Book

TextBook Workbook Teacher's Book

Class I and II			<input type="checkbox"/>			<input type="checkbox"/>
Class III	<input type="checkbox"/>	<input type="checkbox"/>	<input type="checkbox"/>	<input type="checkbox"/>	<input type="checkbox"/>	<input type="checkbox"/>
Class IV	<input type="checkbox"/>	<input type="checkbox"/>	<input type="checkbox"/>	<input type="checkbox"/>	<input type="checkbox"/>	<input type="checkbox"/>
Class V	<input type="checkbox"/>	<input type="checkbox"/>	<input type="checkbox"/>	<input type="checkbox"/>	<input type="checkbox"/>	<input type="checkbox"/>

Opinion about the Curriculum

1. Easy or difficult parts:

.....

.....

2. Interesting or uninteresting parts:

.....

.....

3. Any other comments on:

(a) The TextBook:

.....

(b) The Workbook:

.....

(c) The Teacher's Book:

.....

4. Which other Textbooks have you seen?

.....

.....

5. How do these books compare with them?

.....

.....

.....

.....

6. Your suggestions for improvement in the *Small Science Books*

.....

.....

.....

.....

.....

.....

(Signature)

Please mail to: Homi Bhabha Centre for Science Education, Tata Institute of Fundamental Research, V. N. Purav Marg, Mankhurd, Mumbai 400 088. Mark the envelope 'Homi Bhabha Curriculum - Primary Science'.

Send suggestions by e-mail to : jr@hbcse.tifr.res.in





Small Science

Teacher's Book for Class 1 & 2
TextBook, WorkBook and Teacher's Book
for Classes 3, 4 and 5 (in English)

हलका-फुलका विज्ञान

पाठ्य-पुस्तिका, कार्य-पुस्तिका, शिक्षक-पुस्तिका
कक्षा ३ और ४ के लिए (हिंदी में)

हलके फुलके विज्ञान

शिक्षक पुस्तक इयत्ता १ ली व २ री साठी
पाठ्यपुस्तक, कृती पुस्तक, शिक्षक पुस्तक
इयत्ता ३ री आणि ४ थी साठी (मराठीत)

होमी भाभा विज्ञान शिक्षण केंद्र
टाटा मूलभूत संशोधन संस्था